

## Lenovo ThinkSystem SR630 V3 Server Product Guide

The Lenovo ThinkSystem SR630 V3 is an ideal 2-socket 1U rack server for small businesses up to large enterprises that need industry-leading reliability, management, and security, as well as maximizing performance and flexibility for future growth. The SR630 V3 is based on the new 4th generation Intel Xeon Scalable processor family (formerly codenamed "Sapphire Rapids").

The SR630 V3 is designed to handle a wide range of workloads, such as databases, virtualization and cloud computing, infrastructure security, systems management, enterprise applications, collaboration/email, streaming media, web, and HPC.



Figure 1. Lenovo ThinkSystem SR630 V3

### Did you know?

The SR630 V3 server has been designed to take advantage of the features of the 4th generation Intel Xeon Scalable processors, such as the full performance of 350W 60-core processors, support for 4800 MHz memory and PCIe Gen 5.0 support. The server also offers onboard NVMe PCIe ports that allow direct connections to 16x NVMe SSDs, which results in faster access to store and access data.

## Key features

Combining performance and flexibility, the SR630 V3 server is a great choice for enterprises of all sizes. The server offers a broad selection of drive and slot configurations and offers numerous high performance features. Outstanding reliability, availability, and serviceability (RAS) and high-efficiency design can improve your business environment and can help save operational costs.

### Scalability and performance

The ThinkSystem SR630 V3 offers numerous features to boost performance, improve scalability and reduce costs:

- Supports one or two fourth-generation Intel Xeon Processor Scalable processors
  - Up to 60 cores and 120 threads
  - Core speeds of up to 3.7 GHz
  - TDP ratings of up to 350 W
- Support for DDR5 memory DIMMs to maximize the performance of the memory subsystem:
  - Up to 32 DDR5 memory DIMMs, 16 DIMMs per processor
  - 8 memory channels per processor (2 DIMMs per channel)
  - Supports 1 DIMM per channel operating at 4800 MHz
  - Supports 2 DIMMs per channel operating at 4400 MHz
  - Using 256GB 3DS RDIMMs, the server supports up to 8TB of system memory
- Supports up to three single-width GPUs, each up to 75W for substantial processing power in a 1U system.
- Supports up to 12x 2.5-inch hot-swap drive bays, by using combinations of front-accessible (up to 10 bays) and rear-accessible (2 bays).
- Supports four 3.5-inch drive bays for lower-cost high-capacity HDD storage.
- Supports 16x EDSFF NVMe drives, a new form factor drive for high-density and high-performance storage.
- Supports up to 16x NVMe drives without oversubscription of PCIe lanes (1:1 connectivity) and without the need for additional NVMe adapters. The use of NVMe drives maximizes drive I/O performance, in terms of throughput and latency.
- Supports 12x SATA drives using the onboard SATA controller (no additional adapter needed), enabling lower cost, high capacity storage solution.
- Supports 12x SAS drives using a variety of 12Gb RAID controllers and SAS HBAs.
- The server offers up to three PCIe 5.0 slots, all with rear access, plus an internal bay for a cabled RAID adapter or HBA, plus a slot dedicated to the OCP adapter.
- The server is Compute Express Link (CXL) v1.1 Ready. With CXL 1.1 for next-generation workloads, you can reduce compute latency in the data center and lower TCO. CXL is a protocol that runs across the standard PCIe physical layer and can support both standard PCIe devices as well as CXL devices on the same link.
- Supports high-speed RAID controllers providing 12 Gb SAS connectivity to the drive backplanes. A variety of PCIe 3.0 and PCIe 4.0 RAID adapters are available.
- Supports up to two externally accessible 7mm hot-swap drives for operating system boot functions. Optional RAID with the use of Intel VROC.
- Supports M.2 drives for convenient operating system boot functions or data storage. Available M.2 adapters support either one M.2 drive or two M.2 drives. Optional RAID with the use of Intel VROC.
- The server has a dedicated industry-standard OCP 3.0 small form factor (SFF) slot, with a PCIe 5.0 x16 interface, supporting a variety of Ethernet network adapters. A simple-swap mechanism with a thumbscrew and pull-tab enables tool-less installation and removal of the adapter. The adapter supports shared BMC network sideband connectivity to enable out-of-band systems management.

- The server offers PCI Express 5.0 I/O expansion capabilities that doubles the theoretical maximum bandwidth of PCIe 4.0 (32GT/s in each direction for PCIe Gen 5, compared to 16 GT/s with PCIe Gen 4 and 8 GT/s with PCIe Gen 3). A PCIe 5.0 x16 slot provides 128 GB/s bandwidth, enough to support a dual-port 200GbE network connection.

### **Availability and serviceability**

The SR630 V3 provides many features to simplify serviceability and increase system uptime:

- Designed to run 24 hours a day, 7 days a week
- The server offers Single Device Data Correction (SDDC, also known as Chipkill), Adaptive Double-Device Data Correction (ADDDC, also known as Redundant Bit Steering or RBS), and memory mirroring for redundancy in the event of a non-correctable memory failure. Note: ADDDC is not supported with Value RDIMMs.
- The server offers hot-swap drives, supporting RAID redundancy for data protection and greater system uptime.
- Available M.2 boot adapters support RAID-1 (using Intel VROC) which can enable two SATA or two NVMe M.2 drives to be configured as a redundant pair.
- The server has up to two hot-swap redundant power supplies and up to eight hot-swap redundant fans to provide availability for business-critical applications.
- Optional front-accessible slots and drives so that most major components and cables (except power) are located at the front of the server (planned for 2Q/2023)
- The light path diagnostics feature uses LEDs to lead the technician to failed (or failing) components, which simplifies servicing, speeds up problem resolution, and helps improve system availability.
- Solid-state drives (SSDs) offer more reliability and performance than traditional mechanical HDDs for greater uptime.
- Proactive Platform Alerts (including PFA and SMART alerts): Processors, voltage regulators, memory, internal storage (SAS/SATA HDDs and SSDs, NVMe SSDs, M.2 storage, flash storage adapters), fans, power supplies, RAID controllers, server ambient and subcomponent temperatures. Alerts can be surfaced through the XClarity Controller to managers such as Lenovo XClarity Administrator, VMware vCenter, and Microsoft System Center. These proactive alerts let you take appropriate actions in advance of possible failure, thereby increasing server uptime and application availability.
- The built-in XClarity Controller continuously monitors system parameters, triggers alerts, and performs recovery actions in case of failures to minimize downtime.
- Built-in diagnostics in UEFI, using Lenovo XClarity Provisioning Manager, speed up troubleshooting tasks to reduce service time.
- Lenovo XClarity Provisioning Manager supports diagnostics and can save service data to a USB key drive or remote CIFS share folder for troubleshooting and reduce service time.
- Auto restart in the event of a momentary loss of AC power (based on power policy setting in the XClarity Controller service processor)
- Offers a diagnostics port on the front of the server to allow you to attach an external diagnostics handset for enhanced systems management capabilities.
- Support for the XClarity Administrator Mobile app running on a supported smartphone or tablet and connected to the server through the service-enabled USB port, enables additional local systems management functions.
- Three-year or one-year customer-replaceable unit and onsite limited warranty (varies by geography), 9 x 5 next business day. Optional service upgrades are available.

### **Manageability and security**

Systems management features simplify local and remote management of the SR630 V3:

- The server includes XClarity Controller 2 (XCC2) to monitor server availability. Optional upgrade to XCC Platinum to provide remote control (keyboard video mouse) functions, support for the mounting of remote media files (ISO and IMG image files), boot capture, power capping and new XCC2 Platinum features. New XCC2 Platinum features include System Guard, new security modes including a CNSA-compliant mode, FIPS 140-3 and NIST 800-193 support, and a new Neighbor Group feature.
- Dedicated Ethernet port at the rear of the server for remote management (BMC management). Optional support for a second dedicated BMC management port, installed in the OCP adapter bay.
- Lenovo XClarity Administrator offers comprehensive hardware management tools that help to increase uptime, reduce costs and improve productivity through advanced server management capabilities.
- UEFI-based Lenovo XClarity Provisioning Manager, accessible from F1 during boot, provides system inventory information, graphical UEFI Setup, platform update function, RAID Setup wizard, operating system installation function, and diagnostic functions.
- Support for Lenovo XClarity Energy Manager which captures real-time power and temperature data from the server and provides automated controls to lower energy costs.
- An integrated industry-standard Unified Extensible Firmware Interface (UEFI) enables improved setup, configuration, and updates, and simplifies error handling.
- Support for industry standard management protocols, IPMI 2.0, SNMP 3.0, Redfish REST API, serial console via IPMI
- An integrated hardware Trusted Platform Module (TPM) supporting TPM 2.0 enables advanced cryptographic functionality, such as digital signatures and remote attestation.
- Administrator and power-on passwords help protect from unauthorized access to the server.
- Supports Secure Boot to ensure only a digitally signed operating system can be used. Supported with HDDs and SSDs, as well as 7mm and M.2 drives.
- Industry-standard Advanced Encryption Standard (AES) NI support for faster, stronger encryption.
- Intel Execute Disable Bit functionality can prevent certain classes of malicious buffer overflow attacks when combined with a supported operating system.
- Intel Trusted Execution Technology provides enhanced security through hardware-based resistance to malicious software attacks, allowing an application to run in its own isolated space, protected from all other software running on a system.
- Additional physical security features are an available chassis intrusion switch and available lockable front bezel.

### **Energy efficiency**

The SR630 V3 offers the following energy-efficiency features to save energy, reduce operational costs, and increase energy availability:

- Energy-efficient system board components help lower operational costs.
- High-efficiency power supplies with 80 PLUS Platinum and Titanium certifications
- Solid-state drives (SSDs) consume as much as 80% less power than traditional spinning 2.5-inch HDDs.
- Support for Lenovo XClarity Energy Manager provides advanced data center power notification, analysis, and policy-based management to help achieve lower heat output and reduced cooling needs.
- The server uses hexagonal ventilation holes, which can be grouped more densely than round holes, providing more efficient airflow through the system and thus keeping your system cooler.

## Comparing the SR630 V3 to the SR630 V2

The ThinkSystem SR630 V3 improves on the previous generation SR630 V2, as summarized in the following table.

Table 1. Comparing the SR630 V3 to the previous generation SR630 V2

Feature	SR630 V2	SR630 V3	Benefits
Processor	<ul style="list-style-type: none"> <li>• 2x 3rd Gen Intel Xeon Scalable Processors</li> <li>• Up to 40 cores</li> <li>• TDP ratings up to 270W</li> <li>• 64x PCIe 4.0 lanes per processor</li> </ul>	<ul style="list-style-type: none"> <li>• 2x 4th Gen Intel Xeon Scalable Processors</li> <li>• Up to 60 cores</li> <li>• TDP ratings up to 350W</li> <li>• 80x PCIe 5.0 lanes per processor</li> </ul>	<ul style="list-style-type: none"> <li>• Significant increase in cores per processor</li> <li>• Increased performance</li> <li>• Consolidation of more apps on same number of servers, reducing costs</li> <li>• New PCIe 5.0 support means higher performance networking and NVMe storage</li> </ul>
Memory	<ul style="list-style-type: none"> <li>• DDR4 memory operating up to 3200 MHz</li> <li>• 8 channels per CPU</li> <li>• 32 DIMMs (16 per processor), 2 DIMMs per channel</li> <li>• Supports RDIMMs and 3DS RDIMMs</li> <li>• Up to 8TB of system memory</li> <li>• Intel Optane Persistent Memory 200 Series</li> </ul>	<ul style="list-style-type: none"> <li>• DDR5 memory operating up to 4800 MHz</li> <li>• 8 channels per CPU</li> <li>• 32 DIMMs (16 per processor), 2 DIMMs per channel</li> <li>• Supports RDIMMs, 3DS RDIMMs and 9x4 RDIMMs</li> <li>• Up to 8TB of system memory</li> <li>• No support for Intel Optane Persistent Memory</li> </ul>	<ul style="list-style-type: none"> <li>• New DDR5 memory offers significant performance improvements over DDR4</li> <li>• Support for lower-cost 9x4 DIMMs</li> </ul>
Internal storage	<ul style="list-style-type: none"> <li>• Front: 4x 3.5" SAS/SATA or AnyBay hot-swap drive bays</li> <li>• Front: Up to 8x SAS/SATA hot-swap drives bays</li> <li>• Front: 10x 2.5" SAS/SATA/NVMe (up to 4 AnyBay or 10x NVMe)</li> <li>• Front: 16x E1.S EDSFF NVMe hot-swap drive bays</li> <li>• Rear: Up to 2x 2.5" SAS/SATA or NVMe hot-swap drive bays</li> <li>• Rear: 2x 7mm SATA or NVMe hot-swap drive bays, optional RAID</li> <li>• 12x Onboard NVMe ports</li> <li>• 2x Internal M.2 with optional RAID</li> </ul>	<ul style="list-style-type: none"> <li>• Front: 4x 3.5" SAS/SATA hot-swap drive bays</li> <li>• Front: Up to 8x SAS/SATA hot-swap drives bays</li> <li>• Front: 10x 2.5" SAS/SATA/NVMe (up to 4 AnyBay or 10x NVMe)</li> <li>• Front: 16x E1.S EDSFF NVMe hot-swap drive bays (planned support for E3.S drives)</li> <li>• Front: 4x 2.5" SAS/SATA + 3x PCIe slots (LP, FH, OCP)</li> <li>• Rear: Up to 2x 2.5" SAS/SATA or NVMe hot-swap drive bays</li> <li>• Rear: 2x 7mm SATA or NVMe hot-swap drive bays (RAID support via VROC)</li> <li>• 16x Onboard NVMe ports</li> <li>• 2x Internal M.2 with optional RAID 1 (RAID support via VROC)</li> </ul>	<ul style="list-style-type: none"> <li>• Flexible storage offerings</li> <li>• Support for up to 12x 2.5" NVMe drives</li> <li>• Planned support for E3.S EDSFF drives</li> <li>• New front PCIe slots configuration</li> <li>• No support for M.2 with RAID</li> <li>• No support for 4x 3.5" AnyBay drive bays</li> <li>• Additional NVMe ports means no need for Retimer adapters, freeing up slots for other adapters</li> </ul>

Feature	SR630 V2	SR630 V3	Benefits
RAID	<ul style="list-style-type: none"> <li>8-port and 16-port RAID adapters with up to 8GB flash</li> <li>Support for Lenovo and Broadcom adapters</li> <li>Support for PCIe or Internal cabled (CFF) form factor adapters</li> <li>Support for NVMe drives connected to 940 RAID adapters (Tri-Mode)</li> <li>Storage HBAs available</li> <li>PCIe 3.0 and PCIe 4.0 adapter choices</li> </ul>	<ul style="list-style-type: none"> <li>8-port and 16-port RAID adapters with up to 8GB flash</li> <li>Support for Lenovo and Broadcom adapters</li> <li>Support for PCIe or Internal cabled (CFF) form factor adapters</li> <li>Support for NVMe drives connected to 940 RAID adapters (Tri-Mode)</li> <li>Storage HBAs available</li> <li>PCIe 3.0 and PCIe 4.0 adapter choices with support for Gen 5 adapters when available</li> </ul>	<ul style="list-style-type: none"> <li>Consistent RAID/HBA support</li> <li>Flexible config solution</li> <li>PCIe Gen 5 allows for greater storage performance</li> </ul>
Networking	<ul style="list-style-type: none"> <li>OCP 3.0 slot with PCIe Gen 4 x16 interface (rear of server)</li> <li>Additional PCIe adapters supported</li> <li>1GbE dedicated Management port</li> </ul>	<ul style="list-style-type: none"> <li>OCP 3.0 slot with PCIe Gen 5 x16 interface (rear or front of server) (front OCP slot support planned for 2Q/2023)</li> <li>Additional PCIe adapters supported</li> <li>1GbE dedicated Management port</li> </ul>	<ul style="list-style-type: none"> <li>Improved performance with PCIe Gen 5</li> <li>Optional front-accessible OCP slot</li> </ul>
PCIe	<ul style="list-style-type: none"> <li>Up to 3x PCIe Gen 4 slots (support up to 3x 75W GPUs)</li> <li>Supports either 3x slots (all LP) or 2x slots (LP + FH)</li> <li>FH slot connects to CPU 1 (slot 2)</li> <li>Additional OCP 3.0 slot</li> <li>Supports a RAID/HBA in CFF form factor (does not occupy a PCIe slot)</li> </ul>	<ul style="list-style-type: none"> <li>Up to 2x PCIe Gen 5 slots + 1x PCIe Gen 4 slot (support up to 3x 75W GPUs)</li> <li>Supports either 3x slots (all LP) or 2x slots (LP + FH)</li> <li>FH slot connects to either CPU 1 (slot 2) or CPU 2 (slot 3)</li> <li>Additional OCP 3.0 slot</li> <li>Supports a RAID/HBA in CFF form factor (does not occupy a PCIe slot)</li> <li>Support for 3x front-accessible slots (2x PCIe + 1x OCP) with 4 drive bays (planned for 2Q/2023)</li> </ul>	<ul style="list-style-type: none"> <li>PCIe Gen 5 allows for greater I/O performance</li> <li>Flexible PCIe offerings</li> <li>Front-accessible slots available</li> </ul>
Management and security	<ul style="list-style-type: none"> <li>XClarity Controller</li> <li>Support for full XClarity toolset including XClarity Administrator</li> <li>Platform Firmware Resiliency (PFR) hardware Root of Trust (RoT)</li> <li>Tamper Switch security solution (intrusion switch)</li> </ul>	<ul style="list-style-type: none"> <li>Integrated XClarity Controller 2</li> <li>Support for full XClarity toolset including XClarity Administrator</li> <li>Platform Firmware Resiliency (PFR) hardware Root of Trust (RoT)</li> <li>Tamper Switch security solution (intrusion switch)</li> </ul>	<ul style="list-style-type: none"> <li>New XCC2 offers improved management capabilities</li> <li>Same system management tool with previous generation</li> <li>Silicon-level security solution</li> </ul>

Feature	SR630 V2	SR630 V3	Benefits
Power	<ul style="list-style-type: none"> <li>500W, 750W, 1100W, 1800W AC Platinum/Titanium Hot Plug PSU</li> <li>1100W -48VDC Platinum general support</li> <li>240V HVDC support for PRC customers</li> <li>Active-Standby mode</li> </ul>	<ul style="list-style-type: none"> <li>750W, 1100W, 1800W AC Platinum/Titanium Hot Plug PSU</li> <li>1100W -48VDC Platinum general support</li> <li>240V HVDC support for PRC customers</li> <li>Active-Standby mode</li> </ul>	<ul style="list-style-type: none"> <li>Multiple PSU offerings to suit the configuration selected</li> <li>New ErP Lot 9-compliant offerings</li> <li>Support for Telco customers with -48V requirements</li> </ul>

## Components and connectors

The following figure shows the front of the SR630 V3.

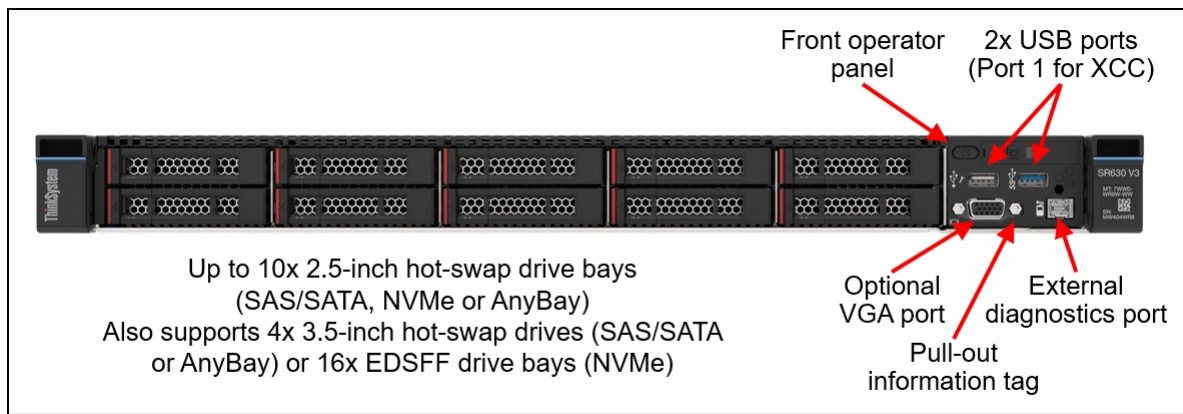

Figure 2. Front view of the ThinkSystem SR630 V3 with 2.5-inch drive bays

For details on the front ports, including the optional front VGA port and front external diagnostic port, see the [Local management](#) section.

The following figure shows the various front configurations supported by the SR630 V3. As shown, the server supports 2.5-inch, 3.5-inch or E1.S EDSFF drive bays. In some configurations, the front of the server includes a pull-out operator panel with LCD display. The SR630 V3 also supports a configuration with 4x 2.5-inch drive bays + 3x front-accessible PCIe slots - a low-profile slot, a full-height slot, and an OCP 3.0 slot.

**Front PCIe slots:** Support for Front PCIe slots is planned for 2Q/2023.

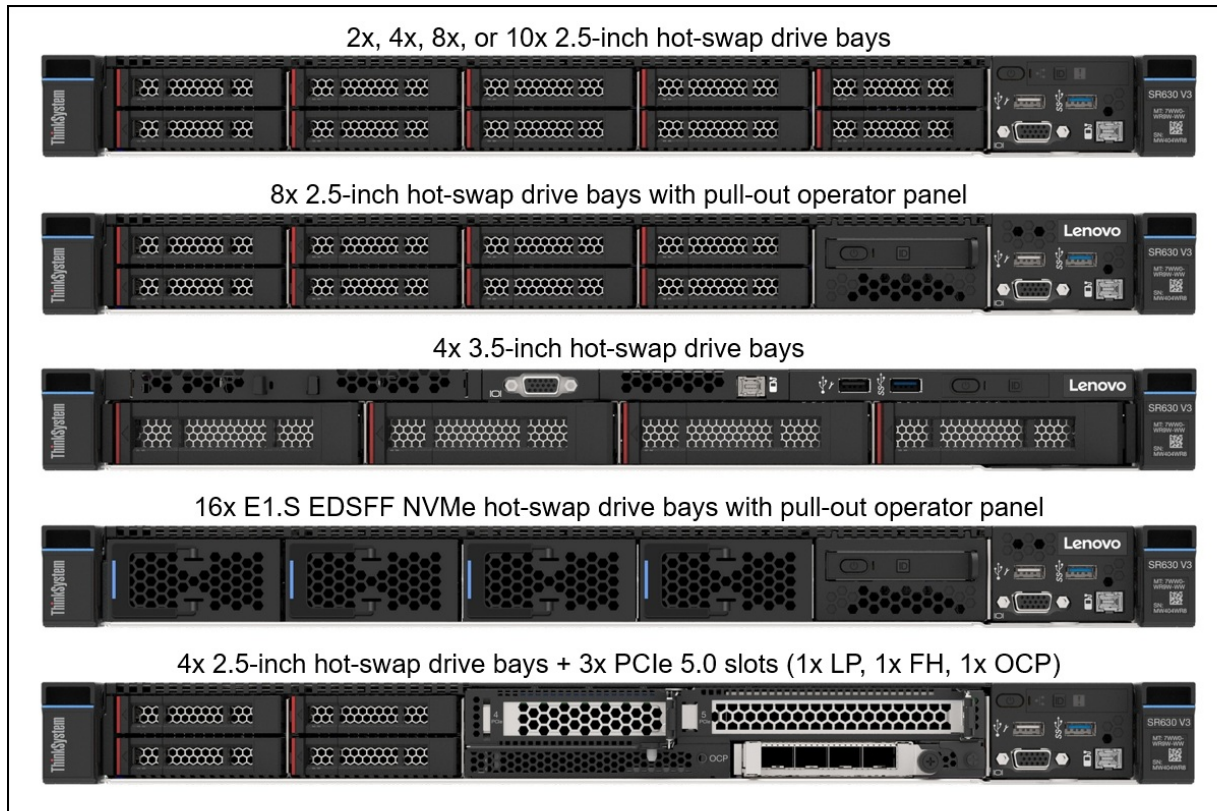

Figure 3. Front configurations of the ThinkSystem SR630 V3

The following figure shows the components visible from the rear of the server. As shown, there are five different configurations available, including two with rear-mounted drive bays: two 2.5-inch hot-swap drive bays (SAS, SATA or NVMe) or 7mm thickness hot-swap drives (SATA or NVMe). There are two configurations with a full-height slot, one where both slots are connected to CPU 1, and the other where the full-height slot is connected to CPU 2.



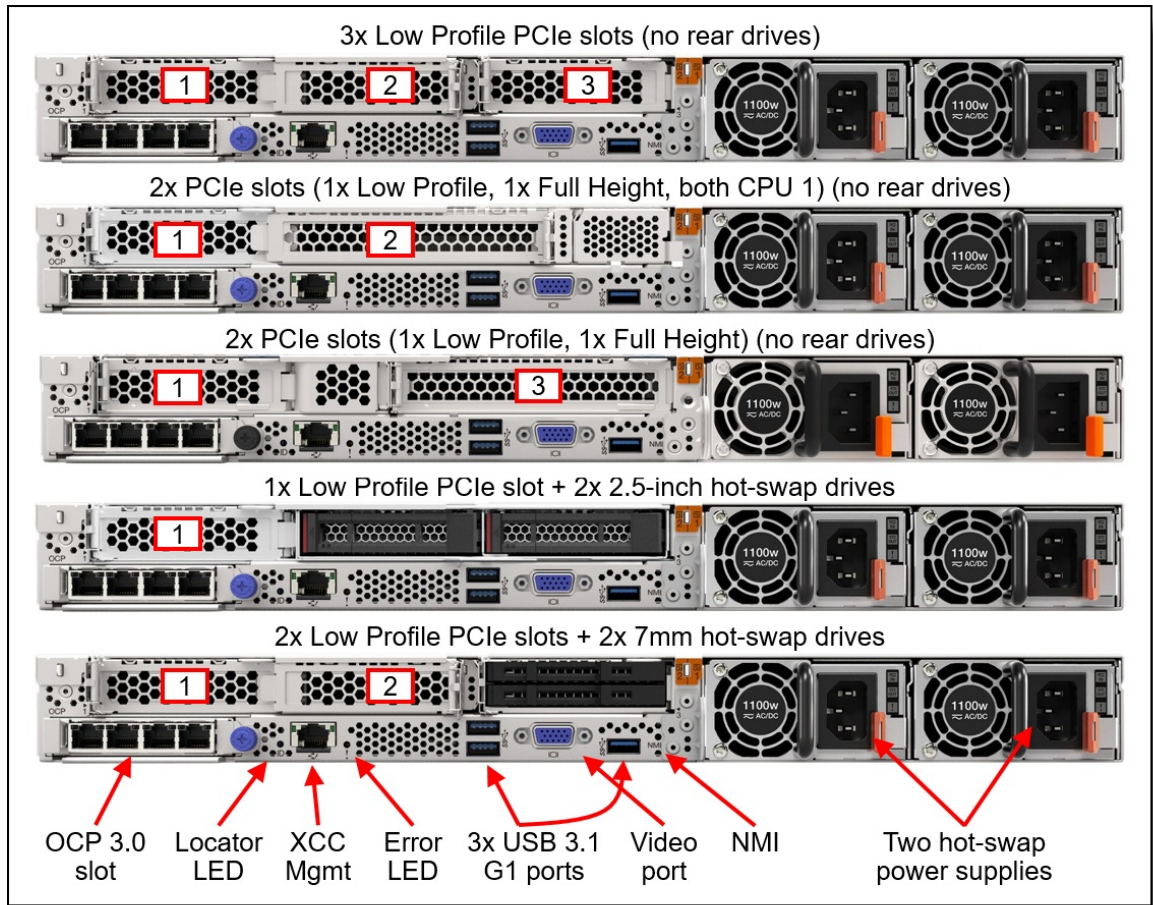

Figure 4. Rear view of the Lenovo ThinkSystem SR630 V3

The following figure shows the locations of key components inside the server.

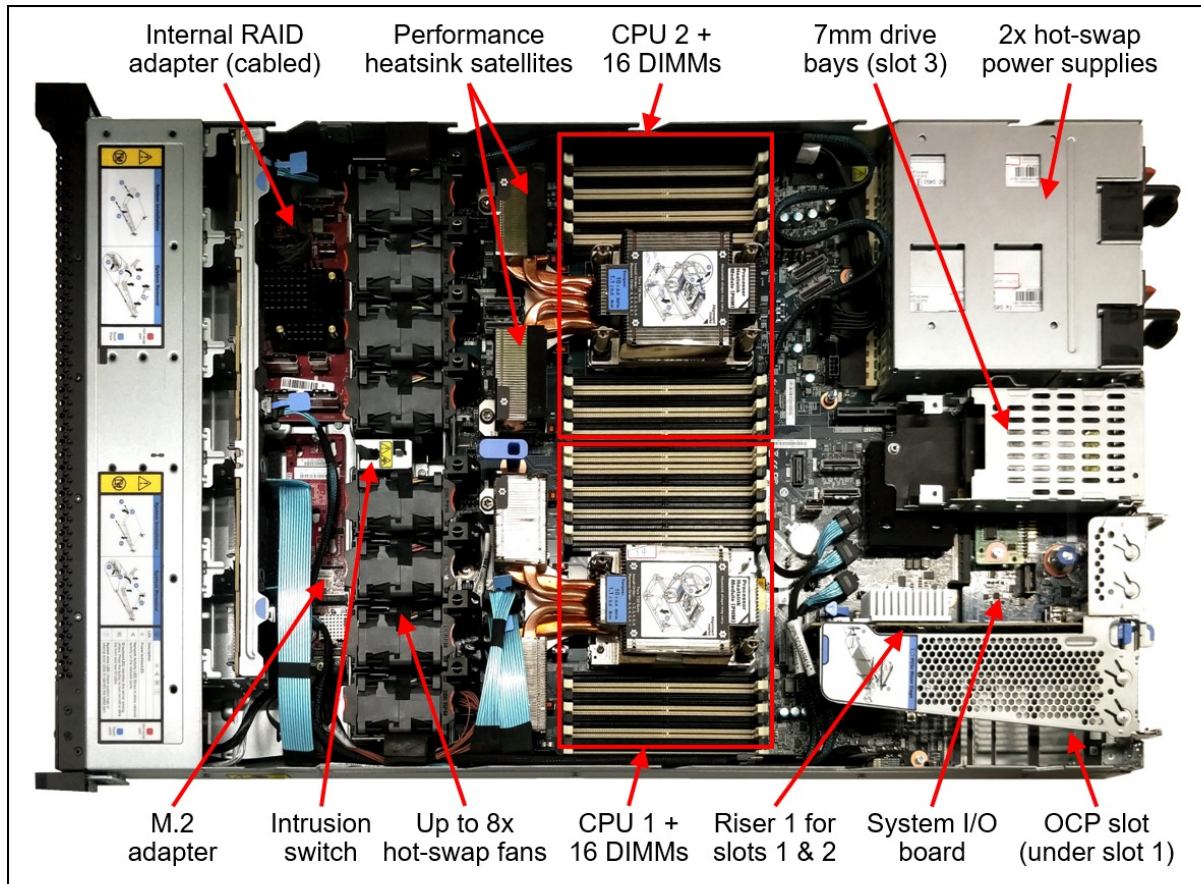

Figure 5. Internal view of the Lenovo ThinkSystem SR630 V3

## System architecture

The following figure shows the architectural block diagram of the SR630 V3, showing the major components and their connections.

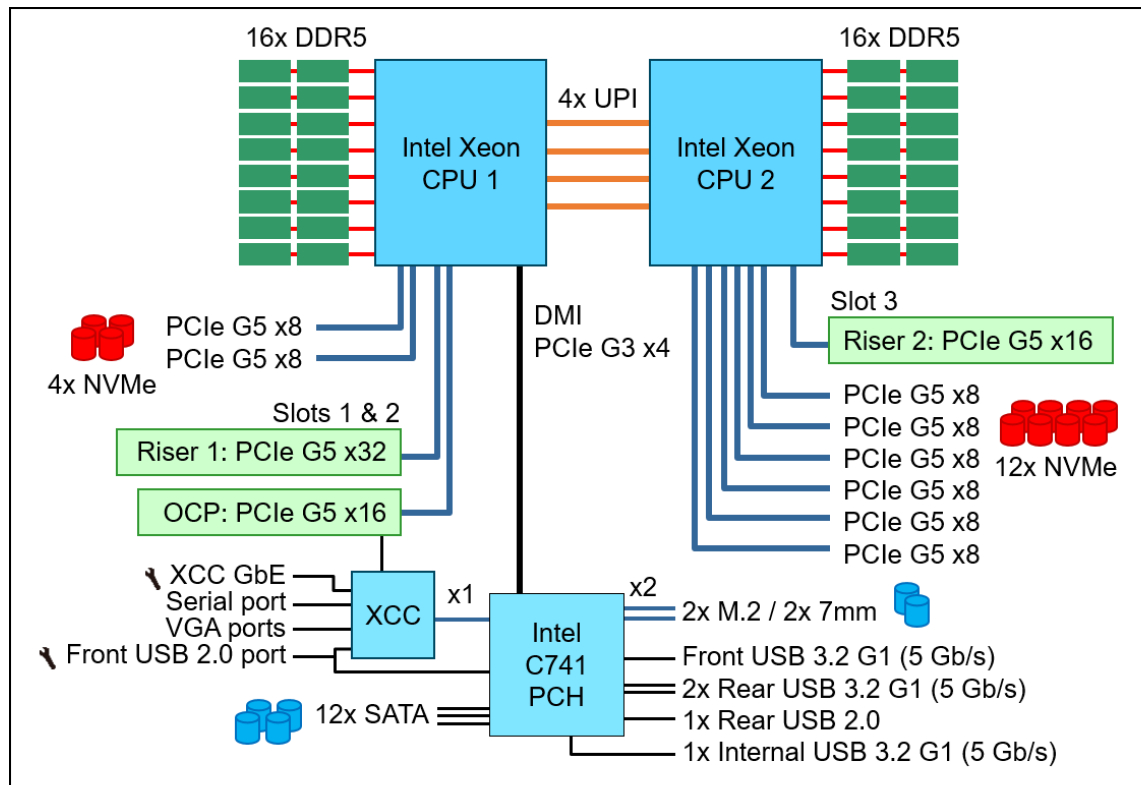

Figure 6. SR630 V3 system architectural block diagram

## Standard specifications

The following table lists the standard specifications.

Table 2. Standard specifications

Components	Specification
Machine types	7D72 - 1 year warranty 7D73 - 3 year warranty
Form factor	1U rack.
Processor	One or two 4th-generation Intel Xeon Scalable processor (formerly codenamed "Sapphire Rapids"). Supports processors up to 60 cores, core speeds of up to 4.0 GHz, and TDP ratings of up to 350 W.
Chipset	Intel C741 "Emmitsburg" chipset, part of the platform codenamed "Eagle Stream"
Memory	32 DIMM slots with two processors (16 DIMM slots per processor). Each processor has 8 memory channels, with 2 DIMMs per channel (DPC). Lenovo TruDDR5 RDIMMs, Value RDIMMs, and 3DS RDIMMs are supported. DIMMs operate at up to 4800 MHz at 1 DPC and up to 4400 MHz at 2 DPC.
Persistent memory	No support.
Memory maximum	Up to 8TB by using 32x 256GB 3DS RDIMMs

Components	Specification
Memory protection	ECC, SDDC (for x4-based memory DIMMs), ADDDC (for x4-based memory DIMMs excluding Value RDIMMs, requires Platinum or Gold processors), and memory mirroring.
Disk drive bays	<p>Up to 4x 3.5-inch or 12x 2.5-inch or 16x EDSFF hot-swap drive bays:</p> <ul style="list-style-type: none"> <li>● Front bays can be one of the following: <ul style="list-style-type: none"> <li>○ 10x 2.5-inch hot-swap: All AnyBay</li> <li>○ 10x 2.5-inch hot-swap: All NVMe</li> <li>○ 10x 2.5-inch hot-swap: 6x SAS/SATA + 4x AnyBay</li> <li>○ 10x 2.5-inch hot-swap: 6x SAS/SATA + 4x NVMe</li> <li>○ 10x 2.5-inch hot-swap: 6x SAS/SATA + 2x AnyBay + 2x NVMe</li> <li>○ 8x 2.5-inch hot-swap SAS/SATA</li> <li>○ 16x EDSFF E1.S form factor hot-swap drives</li> <li>○ 4x 3.5-inch hot-swap SAS/SATA</li> <li>○ 4x 3.5-inch hot-swap AnyBay</li> </ul> </li> <li>● Rear can be one of the following: <ul style="list-style-type: none"> <li>○ 2x 2.5-inch hot-swap SAS/SATA bays</li> <li>○ 2x 2.5-inch hot-swap NVMe bays</li> <li>○ 2x 7mm 2.5-inch hot-swap SATA bays</li> <li>○ 2x 7mm 2.5-inch hot-swap NVMe bays</li> </ul> </li> <li>● Internal M.2 module supporting up to two M.2 drives, for OS boot and drive storage support</li> </ul> <p>See <a href="#">Supported drive bay combinations</a> for details. AnyBay bays support SAS, SATA or NVMe drives. NVMe bays only support NVMe drives. Rear drive bays can be used in conjunction with 2.5-inch front drive bays. The server supports up to 12x NVMe drives all with direct connections (no oversubscription).</p>
Maximum internal storage	<ul style="list-style-type: none"> <li>● 2.5-inch drives: <ul style="list-style-type: none"> <li>○ 368.64TB using 12x 30.72TB 2.5-inch SAS/SATA SSDs</li> <li>○ 184.32TB using 12x 15.36TB 2.5-inch NVMe SSDs</li> <li>○ 28.8TB using 12x 2.4TB 2.5-inch HDDs</li> <li>○ 15.36TB using 2x 7.68TB 7mm SSDs</li> </ul> </li> <li>● EDSFF drives <ul style="list-style-type: none"> <li>○ 122.88TB using 16x 7.68TB EDSFF NVMe SSDs</li> </ul> </li> <li>● 3.5-inch drives: <ul style="list-style-type: none"> <li>○ 80TB using 4x 20TB 3.5-inch HDDs</li> <li>○ 61.44TB using 4x 15.36TB 3.5-inch SAS/SATA SSDs</li> <li>○ 51.2TB using 4x 12.8TB 3.5-inch NVMe SSDs</li> </ul> </li> </ul>
Storage controller	<ul style="list-style-type: none"> <li>● 12x Onboard SATA ports (Intel VROC SATA RAID, formerly known as Intel RSTe RAID)</li> <li>● Up to 16x Onboard NVMe ports (includes Intel VROC NVMe RAID, with optional license for non-Intel NVMe SSDs)</li> <li>● NVMe Retimer Adapter (supports Intel VROC NVMe RAID)</li> <li>● 12 Gb SAS/SATA RAID adapters <ul style="list-style-type: none"> <li>○ 8, 16 or 32 ports</li> <li>○ Up to 8GB flash-backed cache</li> <li>○ PCIe 4.0 or PCIe 3.0 host interface</li> </ul> </li> <li>● 12 Gb SAS/SATA HBA (non-RAID) <ul style="list-style-type: none"> <li>○ 8-port and 16-port</li> <li>○ PCIe 4.0 or PCIe 3.0 host interface</li> </ul> </li> </ul>
Optical drive bays	No internal optical drive.

Components	Specification
Tape drive bays	No internal backup drive.
Network interfaces	Dedicated OCP 3.0 SFF slot with PCIe 5.0 x16 host interface. Supports a variety of 2-port and 4-port adapters with 1, 10, 25 and 100 GbE network connectivity. One port can optionally be shared with the XClarity Controller (XCC) management processor for Wake-on-LAN and NC-SI support.
PCI Expansion slots	<p>Up to 3x PCIe slots (PCIe 5.0 or PCIe 4.0), all with rear access, plus a slot dedicated to the OCP adapter. Slot availability is based on riser selection and rear drive bay selection. Slot 3 requires two processors.</p> <p>Four choices for rear-access slots:</p> <ul style="list-style-type: none"> <li>• 3x PCIe x16 low-profile slots</li> <li>• 1x PCIe x16 full-height half-length slot + 1x PCIe x16 low-profile slot</li> <li>• 1x PCIe x16 low-profile slot (also supports 2x rear 2.5-inch drive bays)</li> <li>• 2x PCIe x16 low-profile slot (also supports 2x rear 7mm 2.5-inch drive bays)</li> </ul> <p>For 2.5-inch front drive configurations, the server supports the installation of a CFF RAID adapter or HBA in a dedicated area that does not consume any of the PCIe slots.</p> <p>The server alternatively supports slots at the front of the server (planned for 2Q/2023):</p> <ul style="list-style-type: none"> <li>• OCP slot</li> <li>• 1x PCIe x16 full-height half-length slot + 1x PCIe x16 low-profile slot</li> </ul> <p><b>Note:</b> Not all slots are available in a 1-processor configuration. See the <a href="#">I/O expansion</a> for details.</p>
GPU support	Supports up to 3x single-wide GPUs
Ports	<p>Front: 1x USB 3.2 G1 (5 Gb/s) port, 1x USB 2.0 port (also for XCC local management), External diagnostics port, optional VGA port.</p> <p>Rear: 2x USB 3.2 G1 (5 Gb/s) ports and 1x USB 2.0 port, 1x VGA video port, 1x RJ-45 1GbE systems management port for XCC remote management. Optional DB-9 COM serial port (installs in slot 3). Optional second RJ-45 1GbE systems management port for XCC remote management (installed in OCP adapter slot).</p> <p>Internal: 1x USB 3.2 G1 connector for operating system or license key purposes</p>
Cooling	Up to 8x N+1 dual-rotor redundant hot-swap 40 mm fans, configuration dependent. One fan integrated in each power supply.
Power supply	Up to two hot-swap redundant AC power supplies, 80 PLUS Platinum or 80 PLUS Titanium certification. 750 W, 1100 W and 1800 W AC options, supporting 220 V AC. 750 W and 1100 W options also support 110V input supply. In China only, all power supply options support 240 V DC. Also available is a 1100W power supply with a -48V DC input.
Video	Embedded graphics with 16 MB memory with 2D hardware accelerator, integrated into the XClarity Controller 2 management controller. Maximum resolution is 1920x1200 32bpp at 60Hz.
Hot-swap parts	Drives, power supplies, and fans.
Systems management	Operator panel with status LEDs. Optional External Diagnostics Handset with LCD display. Models with 8x 2.5-inch front drive bays can optionally support an Integrated Diagnostics Panel. XClarity Controller 2 (XCC2) embedded management based on the ASPEED AST2600 baseboard management controller (BMC), XClarity Administrator centralized infrastructure delivery, XClarity Integrator plugins, and XClarity Energy Manager centralized server power management. Optional XCC Platinum to enable remote control functions and other features.
Security features	Chassis intrusion switch, Power-on password, administrator's password, Root of Trust module supporting TPM 2.0 and Platform Firmware Resiliency (PFR). Optional lockable front security bezel.

Components	Specification
Operating systems supported	Microsoft Windows Server, Red Hat Enterprise Linux, SUSE Linux Enterprise Server, VMware ESXi, Ubuntu Server. See the <a href="#">Operating system support</a> section for specifics.
Limited warranty	Three-year or one-year (model dependent) customer-replaceable unit and onsite limited warranty with 9x5 next business day (NBD).
Service and support	Optional service upgrades are available through Lenovo Services: 4-hour or 2-hour response time, 6-hour fix time, 1-year or 2-year warranty extension, software support for Lenovo hardware and some third-party applications.
Dimensions	Width: 440 mm (17.3 in.), height: 43 mm (1.7 in.), depth: 773 mm (30.4 in.). See <a href="#">Physical and electrical specifications</a> for details.
Weight	Maximum weight: 20.2 kg (44.5 lb)

## Models

ThinkSystem SR630 V3 models can be configured by using the [Lenovo Data Center Solution Configurator \(DCSC\)](#).

Configure-to-order (CTO) models are used to create models with factory-integrated server customizations. For CTO models, two base CTO models are available for the SR630 V3 as listed in the following table, CTO1WW and CTOLWW:

- The CTO1WW base CTO model is for general business and is selectable by choosing **General Purpose** mode in DCSC.
- The CTOLWW base model is intended for High Performance Computing (HPC) and Artificial Intelligence (AI) configurations and solutions, including configurations for Lenovo Scalable Infrastructure (LeSI), and is enabled using either the **HPC & AI LeSI Solutions** mode or **HPC & AI Hardware** mode in DCSC. CTOLWW configurations can also be built using [System x and Cluster Solutions Configurator \(x-config\)](#).

Preconfigured server models may also be available for the SR630 V3, however these are region-specific; that is, each region may define their own server models, and not all server models are available in every region.

The following table lists the base CTO models of the ThinkSystem SR630 V3 server.

Table 3. Base CTO models

Machine Type/Model General purpose	Machine Type/Model for HPC and AI	Description
7D73CTO1WW	7D73CTOLWW	ThinkSystem SR630 V3 – 3-year Warranty
7D72CTO1WW	7D72CTOLWW	ThinkSystem SR630 V3 – 1-year Warranty
7D74CTO1WW	7D74CTOLWW	ThinkSystem SR630 V3 – SAP HANA configurations with 3-year warranty

Models of the SR630 V3 are defined based on whether the server has 2.5-inch drive bays at the front (called the 10x 2.5" chassis or simply the 2.5-inch chassis) or whether it has 3.5-inch drive bays at the front (called the 3.5-inch chassis). For models, the feature codes for these chassis bases are as listed in the following table.

Table 4. Chassis base feature codes

Feature code	Description	Purpose
BLK4	ThinkSystem V3 1U 10x2.5" Chassis	4x, 8x, or 10x front 2.5-inch hot-swap drives without front PCIe slots, or 16x EDSFF E1.S drive bays
BLK3	ThinkSystem V3 1U 4x3.5" Chassis	4x front 3.5-inch hot-swap drive bays
BQ7M	ThinkSystem V3 1U 4x2.5" Chassis	Front PCIe slots with 4x 2.5-inch hot-swap drive bays

The following tables list the available models, grouped by region.

- [Models for Asia Pacific region](#)
- [Models for Australia and New Zealand](#)
- [Models for EMEA region](#)

Refer to the Specifications section for information about standard features of the server.

Common to all models:

- Power supplies are Platinum unless otherwise stated
- All models include the External Diagnostics Handset port
- All models include a Toolless Slide Rail Kit

### Models for Asia Pacific region

The following table lists the models for the Asia Pacific region: Australia, Bangladesh, Brunei, Hong Kong, India, Japan, Korea, Sri Lanka, Malaysia, New Zealand, Philippines, Singapore, Thailand, Taiwan, Vietnam

Table 5. Models for Asia Pacific markets

Model	Intel Xeon Scalable processor†	Memory	RAID	Drive bays	OCP	Slots	Power supply	XCC	Fans	Front VGA	Intru. sw.
Standard models with a 3-year warranty (machine type 7D73)											
7D73A01XAP	1x Silver 4410T 10C 150W 2.7G	1x 16GB	9350-8i	8x 2.5" SAS; Open bay	4x1Gb 5719	2x LP Gen4	1x750W	Std	6x Std	Yes	Opt
7D73A01ZAP	1x Silver 4410T 10C 150W 2.7G	1x 16GB	9350-8i	4x 3.5" SAS; Open bay	4x1Gb 5719	2x LP Gen4	1x750W	Std	6x Std	Yes	Opt
7D73A01VAP	1x Silver 4410Y 12C 150W 2.0G	1x 16GB	9350-8i	8x 2.5" SAS; Open bay	4x1Gb 5719	2x LP Gen4	1x750W	Std	6x Std	Yes	Opt
7D73A01WAP	1x Silver 4410Y 12C 150W 2.0G	1x 16GB	9350-8i	4x 3.5" SAS; Open bay	4x1Gb 5719	2x LP Gen4	1x750W	Std	6x Std	Yes	Opt
7D73A01FAP	1x Gold 5415+ 8C 150W 2.9G	1x 16GB	9350-8i	8x 2.5" SAS; Open bay	4x1Gb 5719	2x LP Gen4	1x750W	Std	6x Std	Yes	Opt
7D73A01YAP	1x Gold 5415+ 8C 150W 2.9G	1x 16GB	9350-8i	4x 3.5" SAS; Open bay	4x1Gb 5719	2x LP Gen4	1x750W	Std	6x Std	Yes	Opt

† Processor description: Processor model, number of cores, thermal design power (TDP), core frequency

## Models for Australia and New Zealand

**AP models:** Customers in Australia and New Zealand also have access to the [Asia Pacific region](#) models.

Table 6. Models for Australia and New Zealand

Model	Intel Xeon Scalable processor†	Memory	RAID	Drive bays	OCP	Slots	Power supply	XCC	Fans	Front VGA	Intru. sw.
TopSeller models with a 3-year warranty (machine type 7D73)											
7D73A01PAU	1x Silver 4410Y 12C 150W 2.0G	1x 16GB	5350-8i	8x 2.5" SAS; Open bay	Open	2x LP Gen4	1x750W	Std	6x Perf	Yes	Opt
7D73A01RAU	1x Silver 4410Y 12C 150W 2.0G	1x 16GB	9350-8i	8x 2.5" SAS; Open bay	Open	2x LP Gen4	1x750W	Std	6x Perf	Yes	Opt
7D73A01QAU	1x Gold 5416S 16C 150W 2.0G	1x 32GB 2Rx8	9350-8i	8x 2.5" SAS; Open bay	Open	2x LP Gen4	1x750W	Std	6x Perf	Yes	Opt
7D73A01SAU	1x Gold 5418Y 24C 185W 2.0G	1x 32GB 2Rx8	Option	10x 2.5" Any; Open bay	Open	2x LP Gen5	1x750W	Std	6x Perf	Yes	Opt
7D73A01TAU	1x Gold 5418Y 24C 185W 2.0G	1x 32GB 2Rx8	9350-8i	8x 2.5" SAS; Open bay	Open	2x LP Gen4	1x750W	Std	6x Perf	Yes	Opt

† Processor description: Processor model, number of cores, thermal design power (TDP), core frequency



## Models for EMEA region

Table 7. Models for EMEA region

Model	Intel Xeon Scalable processor†	Memory	RAID	Drive bays	OCP	Slots	Power supply	XCC	Fans	Front VGA	Intru. sw.
Standard models with a 3-year warranty (machine type 7D73)											
7D73A01DEA	1x Silver 4410Y 12C 150W 2.0G	1x 64GB	940-8i 4GB	8x 2.5" SAS; Open bay	Open	2x LP Gen5	1x1100W Titanium	Std	6x Perf	Opt	Yes
7D73A01LEA	1x Silver 4410Y 12C 150W 2.0G	1x 64GB	9350-8i 2GB Int	8x 2.5" SAS; Open bay	Open	Open	1x1100W Titanium	Plat	6x Std	Opt	Yes
7D73A01JEA	1x Silver 4416+ 20C 165W 2.0G	1x 64GB	9350-8i 2GB Int	8x 2.5" SAS; Open bay	Open	Open	1x1100W Titanium	Plat	6x Perf	Opt	Yes
7D73A01HEA	1x Gold 5415+ 8C 150W 2.9G	1x 64GB	9350-8i 2GB Int	8x 2.5" SAS; Open bay	Open	Open	1x1100W Titanium	Plat	6x Std	Opt	Yes
7D73A01EEA	1x Gold 5416S 16C 150W 2.0G	1x 64GB	940-8i 4GB	8x 2.5" SAS; Open bay	Open	2x LP Gen5	1x1100W Titanium	Std	6x Perf	Opt	Yes
7D73A01KEA	1x Gold 5416S 16C 150W 2.0G	1x 64GB	9350-8i 2GB Int	8x 2.5" SAS; Open bay	Open	Open	1x1100W Titanium	Plat	6x Std	Opt	Yes
7D73A01GEA	1x Gold 5418Y 24C 185W 2.0G	1x 64GB	9350-8i 2GB Int	8x 2.5" SAS; Open bay	Open	Open	1x1100W Titanium	Plat	6x Perf	Opt	Yes
7D73A01NEA	1x Gold 5418Y 24C 185W 2.0G	1x 64GB	940-8i 4GB	8x 2.5" SAS; Open bay	Open	2x LP Gen5	1x1100W Titanium	Std	6x Perf	Opt	Yes
7D73A01AEA	1x Gold 6426Y 16C 185W 2.5G	1x 64GB	9350-8i 2GB Int	8x 2.5" SAS; Open bay	Open	Open	1x1100W Titanium	Std	6x Perf	Opt	Yes
7D73A019EA	1x Gold 6430 32C 270W 2.1G	1x 64GB	9350-8i 2GB Int	8x 2.5" SAS; Open bay	Open	Open	1x1100W Titanium	Std	6x Perf	Opt	Yes
7D73A01MEA	1x Gold 6430 32C 270W 2.1G	1x 64GB	940-8i 4GB	8x 2.5" SAS; Open bay	Open	2x LP Gen5	1x1100W Titanium	Std	6x Perf	Opt	Yes
7D73A01CEA	1x Gold 6438Y+ 32C 205W 2.0G	1x 64GB	9350-8i 2GB Int	8x 2.5" SAS; Open bay	Open	Open	1x1100W Titanium	Std	6x Perf	Opt	Yes
7D73A01BEA	1x Gold 6444Y 16C 270W 3.6G	1x 64GB	9350-8i 2GB Int	8x 2.5" SAS; Open bay	Open	Open	1x1100W Titanium	Std	6x Perf	Opt	Yes
7D73A01UEA	1x Gold 6448Y 32C 225W 2.1G	1x 64GB	9350-8i 2GB Int	8x 2.5" SAS; Open bay	Open	Open	1x1100W Titanium	Std	6x Perf	Opt	Yes

† Processor description: Processor model, number of cores, thermal design power (TDP), core frequency

## Processors

The SR630 V3 supports processors in the 4th Gen Intel Xeon Scalable Processor family. The server supports one or two processors.

Topics in this section:

- [Processor options](#)
- [Processor features](#)
- [One-processor configurations](#)
- [Thermal requirements by processor](#)
- [UEFI operating modes](#)

## Processor options

All supported processors have the following characteristics:

- 8 DDR5 memory channels at 2 DIMMs per channel
- Up to 4 UPI links between processors at 16 GT/s
- 80 PCIe 5.0 I/O lanes

The following table lists the processors that are currently supported by the SR630 V3.

Table 8. SR630 V3 processor support

Part number	Feature code	SKU	Description	Quantity supported
CTO only	BQ68	3408U	Intel Xeon Bronze 3408U 8C 125W 1.8GHz Processor	1*
4XG7A83807	BQ64	4410T	ThinkSystem SR630 V3 Intel Xeon Silver 4410T 10C 150W 2.7GHz Processor Option Kit w/o Fan	2
4XG7A83810	BQ67	4410Y	ThinkSystem SR630 V3 Intel Xeon Silver 4410Y 12C 150W 2.0GHz Processor Option Kit w/o Fan	2
4XG7A83812	BQ69	4416+	ThinkSystem SR630 V3 Intel Xeon Silver 4416+ 20C 165W 2.0GHz Processor Option Kit w/o Fan	2
CTO only	BQ6J	5411N	Intel Xeon Gold 5411N 24C 165W 1.9GHz Processor	1*
CTO only	BU1V	5412U	Intel Xeon Gold 5412U 24C 185W 2.1GHz Processor	1*
4XG7A83806	BQ63	5415+	ThinkSystem SR630 V3 Intel Xeon Gold 5415+ 8C 150W 2.9GHz Processor Option Kit w/o Fan	2
4XG7A83823	BQ6L	5416S	ThinkSystem SR630 V3 Intel Xeon Gold 5416S 16C 150W 2.0GHz Processor Option Kit w/o Fan	2
4XG7A83820	BQ6H	5418N	ThinkSystem SR630 V3 Intel Xeon Gold 5418N 24C 165W 1.8GHz Processor Option Kit w/o Fan	2
4XG7A83809	BQ66	5418Y	ThinkSystem SR630 V3 Intel Xeon Gold 5418Y 24C 185W 2.0GHz Processor Option Kit w/o Fan	2
4XG7A83808	BQ65	5420+	ThinkSystem SR630 V3 Intel Xeon Gold 5420+ 28C 205W 2.0GHz Processor Option Kit w/o Fan	2
CTO only	BPPD	6414U	Intel Xeon Gold 6414U 32C 250W 2.0GHz Processor	1*
4XG7A83815	BQ6C	6416H	ThinkSystem SR630 V3 Intel Xeon Gold 6416H 18C 165W 2.2GHz Processor Option Kit w/o Fan	2
4XG7A83814	BQ6B	6418H	ThinkSystem SR630 V3 Intel Xeon Gold 6418H 24C 185W 2.1GHz Processor Option Kit w/o Fan	2
CTO only	BQ6G	6421N	Intel Xeon Gold 6421N 32C 185W 1.8GHz Processor	1*
4XG7A83803	BPQF	6426Y	ThinkSystem SR630 V3 Intel Xeon Gold 6426Y 16C 185W 2.5GHz Processor Option Kit w/o Fan	2
4XG7A83818	BQ6F	6428N	ThinkSystem SR630 V3 Intel Xeon Gold 6428N 32C 185W 1.8GHz Processor Option Kit w/o Fan	2
4XG7A83777	BPPC	6430	ThinkSystem SR630 V3 Intel Xeon Gold 6430 32C 270W 2.1GHz Processor Option Kit w/o Fan	2
4XG7A83801	BPQC	6434	ThinkSystem SR630 V3 Intel Xeon Gold 6434 8C 195W 3.7GHz Processor Option Kit w/o Fan	2
4XG7A83817	BQ6E	6434H	ThinkSystem SR630 V3 Intel Xeon Gold 6434H 8C 195W 3.7GHz Processor Option Kit w/o Fan	2
4XG7A83822	BQ6K	6438M	ThinkSystem SR630 V3 Intel Xeon Gold 6438M 32C 205W 2.2GHz Processor Option Kit w/o Fan	2

Part number	Feature code	SKU	Description	Quantity supported
4XG7A83816	BQ6D	6438N	ThinkSystem SR630 V3 Intel Xeon Gold 6438N 32C 205W 2.0GHz Processor Option Kit w/o Fan	2
4XG7A83804	BQ62	6438Y+	ThinkSystem SR630 V3 Intel Xeon Gold 6438Y+ 32C 205W 2.0GHz Processor Option Kit w/o Fan	2
4XG7A83802	BPQE	6442Y	ThinkSystem SR630 V3 Intel Xeon Gold 6442Y 24C 225W 2.6GHz Processor Option Kit w/o Fan	2
4XG7A83800	BPQB	6444Y	ThinkSystem SR630 V3 Intel Xeon Gold 6444Y 16C 270W 3.6GHz Processor Option Kit w/o Fan	2
4XG7A83813	BQ6A	6448H	ThinkSystem SR630 V3 Intel Xeon Gold 6448H 32C 250W 2.4GHz Processor Option Kit w/o Fan	2
4XG7A83805	BPQD	6448Y	ThinkSystem SR630 V3 Intel Xeon Gold 6448Y 32C 225W 2.1GHz Processor Option Kit w/o Fan	2
4XG7A83788	BPPM	6454S	ThinkSystem SR630 V3 Intel Xeon Gold 6454S 32C 270W 2.2GHz Processor Option Kit w/o Fan	2
4XG7A83785	BPPH	8444H	ThinkSystem SR630 V3 Intel Xeon Platinum 8444H 16C 270W 2.9GHz Processor Option Kit w/o Fan	2
4XG7A83783	BPPG	8450H	ThinkSystem SR630 V3 Intel Xeon Platinum 8450H 28C 250W 2.0GHz Processor Option Kit w/o Fan	2
4XG7A83778	BPPB	8452Y	ThinkSystem SR630 V3 Intel Xeon Platinum 8452Y 36C 300W 2.0GHz Processor Option Kit w/o Fan	2
4XG7A83782	BPPF	8454H	ThinkSystem SR630 V3 Intel Xeon Platinum 8454H 32C 270W 2.1GHz Processor Option Kit w/o Fan	2
4XG7A83795	BPPT	8458P	ThinkSystem SR630 V3 Intel Xeon Platinum 8458P 44C 350W 2.7GHz Processor Option Kit w/o Fan	2
4XG7A83781	BPPN	8460H	ThinkSystem SR630 V3 Intel Xeon Platinum 8460H 40C 330W 2.2GHz Processor Option Kit w/o Fan	2
4XG7A83789	BPPQ	8460Y+	ThinkSystem SR630 V3 Intel Xeon Platinum 8460Y+ 40C 300W 2.0GHz Processor Option Kit w/o Fan	2
CTO only	BPPK	8461V	Intel Xeon Platinum 8461V 48C 300W 2.2GHz Processor	1*
4XG7A83799	BPQA	8462Y+	ThinkSystem SR630 V3 Intel Xeon Platinum 8462Y+ 32C 300W 2.8GHz Processor Option Kit w/o Fan	2
4XG7A83796	BPPU	8468	ThinkSystem SR630 V3 Intel Xeon Platinum 8468 48C 350W 2.1GHz Processor Option Kit w/o Fan	2
4XG7A83780	BPPE	8468H	ThinkSystem SR630 V3 Intel Xeon Platinum 8468H 48C 330W 2.1GHz Processor Option Kit w/o Fan	2
4XG7A83791	BPPP	8468V	ThinkSystem SR630 V3 Intel Xeon Platinum 8468V 48C 330W 2.4GHz Processor Option Kit w/o Fan	2
4XG7A83797	BN0N	8470	ThinkSystem SR630 V3 Intel Xeon Platinum 8470 52C 350W 2.0GHz Processor Option Kit w/o Fan	2
4XG7A83786	BPPJ	8470N	ThinkSystem SR630 V3 Intel Xeon Platinum 8470N 52C 300W 1.7GHz Processor Option Kit w/o Fan	2
CTO only	BPPR	8471N	Intel Xeon Platinum 8471N 52C 300W 1.8GHz Processor	1*
4XG7A83798	BN0M	8480+	ThinkSystem SR630 V3 Intel Xeon Platinum 8480+ 56C 350W 2.0GHz Processor Option Kit w/o Fan	2
4XG7A83794	BPPS	8490H	ThinkSystem SR630 V3 Intel Xeon Platinum 8490H 60C 350W 1.9GHz Processor Option Kit w/o Fan	2

\* These processors are single-socket capable processors and are only available in configure-to-order builds or in preconfigured models. Not available as option part numbers.

Configuration notes:

- Processor options include a heatsink but do not include a system fan

## Processor features

The 4th Gen Intel Xeon Scalable processors introduce new embedded accelerators to add even more processing capability:

- Intel Data Streaming Accelerator (Intel DSA)  
Drive high performance for storage, networking, and data-intensive workloads by improving streaming data movement and transformation operations. Intel Data Streaming Accelerator (Intel DSA) is designed to offload the most common data movement tasks that cause overhead in data center-scale deployments. Intel DSA helps speed up data movement across the CPU, memory, and caches, as well as all attached memory, storage, and network devices.
- QuickAssist Technology (Intel QAT)  
Help reduce system resource consumption by providing accelerated cryptography, key protection, and data compression with Intel QuickAssist Technology (Intel QAT). By offloading encryption and decryption, this built-in accelerator helps free up processor cores and helps systems serve a larger number of clients.
- Intel Dynamic Load Balancer (Intel DLB)  
Improve the system performance related to handling network data on multi-core Intel Xeon Scalable processors. Intel Dynamic Load Balancer (Intel DLB) enables the efficient distribution of network processing across multiple CPU cores/threads and dynamically distributes network data across multiple CPU cores for processing as the system load varies. Intel DLB also restores the order of networking data packets processed simultaneously on CPU cores.
- Intel In-Memory Analytics Accelerator (Intel IAA)  
Run database and analytics workloads faster, with potentially greater power efficiency. Intel In-Memory Analytics Accelerator (Intel IAA) increases query throughput and decreases the memory footprint for in-memory database and big data analytics workloads. Intel IAA is ideal for in-memory databases, open source databases and data stores like RocksDB, Redis, Cassandra, and MySQL.

The following table summarizes the key features of all supported processors in the SR630 V3.

Table 9. Processor features

CPU model	Cores/ threads	Core speed (Base / TB max†)	L3 cache*	Max memory speed	UPI 2.0 links & speed	TDP	Accelerators				SGX Enclave Size
							DSA	QAT	DLB	IAA	
3408U	8 / 8**	1.8 / 1.9 GHz	22.5 MB*	4000 MHz	None‡	125W	1	0	0	0	64 GB
4410T	10 / 20	2.7 / 4.0 GHz	26.25 MB*	4000 MHz	2 / 16 GT/s	150W	1	0	0	0	64 GB
4410Y	12 / 24	2.0 / 3.9 GHz	30 MB*	4000 MHz	2 / 16 GT/s	150W	1	0	0	0	64 GB
4416+	20 / 40	2.0 / 3.9 GHz	37.5 MB	4000 MHz	2 / 16 GT/s	165W	1	1	1	1	64 GB
5411N	24 / 48	1.9 / 3.9 GHz	45 MB	4400 MHz	None‡	165W	1	2	2	0	128 GB
5412U	24 / 48	2.1 / 3.9 GHz	45 MB	4400 MHz	None‡	185W	1	0	0	0	128 GB
5415+	8 / 16	2.9 / 4.1 GHz	22.5 MB*	4400 MHz	3 / 16 GT/s	150W	1	1	1	1	128 GB
5416S	16 / 32	2.0 / 4.0 GHz	30 MB	4400 MHz	3 / 16 GT/s	150W	1	2	2	0	128 GB
5418N	24 / 48	1.8 / 3.8 GHz	45 MB	4000 MHz	3 / 16 GT/s	165W	1	2	2	0	128 GB
5418Y	24 / 48	2.0 / 3.8 GHz	45 MB	4400 MHz	3 / 16 GT/s	185W	1	0	0	0	128 GB
5420+	28 / 56	2.0 / 4.1 GHz	52.5 MB	4400 MHz	3 / 16 GT/s	205W	1	1	1	1	128 GB
6414U	32 / 64	2.0 / 3.4 GHz	60 MB	4800 MHz	None‡	250W	1	0	0	0	128 GB

CPU model	Cores/ threads	Core speed (Base / TB max†)	L3 cache*	Max memory speed	UPI 2.0 links & speed	TDP	Accelerators				SGX Enclave Size
							DSA	QAT	DLB	IAA	
6416H	18 / 36	2.2 / 4.2 GHz	45 MB*	4800 MHz	3 / 16 GT/s	165W	1	0	0	1	512 GB
6418H	24 / 48	2.1 / 4.0 GHz	60 MB*	4800 MHz	3 / 16 GT/s	185W	1	0	0	1	512 GB
6421N	32 / 64	1.8 / 3.6 GHz	60 MB	4400 MHz	None‡	185W	1	0	0	0	128 GB
6426Y	16 / 32	2.5 / 4.1 GHz	37.5 MB*	4800 MHz	3 / 16 GT/s	185W	1	0	0	0	128 GB
6428N	32 / 64	1.8 / 3.8 GHz	60 MB	4000 MHz	3 / 16 GT/s	185W	1	2	2	0	128 GB
6430	32 / 64	2.1 / 3.4 GHz	60 MB	4400 MHz	3 / 16 GT/s	270W	1	0	0	0	128 GB
6434	8 / 16	3.7 / 4.1 GHz	22.5 MB*	4800 MHz	3 / 16 GT/s	195W	1	0	0	0	128 GB
6434H	8 / 16	3.7 / 4.1 GHz	22.5 MB*	4800 MHz	3 / 16 GT/s	195W	1	0	0	1	512 GB
6438M	32 / 64	2.2 / 3.9 GHz	60 MB	4800 MHz	3 / 16 GT/s	205W	1	0	0	1	128 GB
6438N	32 / 64	2.0 / 3.6 GHz	60 MB	4800 MHz	3 / 16 GT/s	205W	1	2	2	0	128 GB
6438Y+	32 / 64	2.0 / 4.0 GHz	60 MB	4800 MHz	3 / 16 GT/s	205W	1	1	1	1	128 GB
6442Y	24 / 48	2.6 / 4.0 GHz	60 MB*	4800 MHz	3 / 16 GT/s	225W	1	0	0	0	128 GB
6444Y	16 / 32	3.6 / 4.1 GHz	45 MB*	4800 MHz	3 / 16 GT/s	270W	1	0	0	0	128 GB
6448H	32 / 64	2.4 / 4.1 GHz	60 MB	4800 MHz	3 / 16 GT/s	250W	1	2	2	1	512 GB
6448Y	32 / 64	2.1 / 4.1 GHz	60 MB	4800 MHz	3 / 16 GT/s	225W	1	0	0	0	128 GB
6454S	32 / 64	2.2 / 3.4 GHz	60 MB	4800 MHz	4 / 16 GT/s	270W	4	4	4	0	128 GB
8444H	16 / 32	2.9 / 4.0 GHz	45 MB*	4800 MHz	4 / 16 GT/s	270W	4	0	0	4	512 GB
8450H	28 / 56	2.0 / 3.5 GHz	75 MB*	4800 MHz	4 / 16 GT/s	250W	4	0	0	4	512 GB
8452Y	36 / 72	2.0 / 3.2 GHz	67.5 MB	4800 MHz	4 / 16 GT/s	300W	1	0	0	0	128 GB
8454H	32 / 64	2.1 / 3.4 GHz	82.5 MB*	4800 MHz	4 / 16 GT/s	270W	4	4	4	4	512 GB
8458P	44 / 88	2.7 / 3.8 GHz	82.5 MB	4800 MHz	3 / 16 GT/s	350W	1	1	1	1	512 GB
8460H	40 / 80	2.2 / 3.8 GHz	105 MB*	4800 MHz	4 / 16 GT/s	330W	4	0	0	4	512 GB
8460Y+	40 / 80	2.0 / 3.7 GHz	105 MB*	4800 MHz	4 / 16 GT/s	300W	1	1	1	1	128 GB
8461V	48 / 96	2.2 / 3.7 GHz	97.5 MB*	4800 MHz	None‡	300W	1	1	1	1	128 GB
8462Y+	32 / 64	2.8 / 4.1 GHz	60 MB	4800 MHz	3 / 16 GT/s	300W	1	1	1	1	128 GB
8468	48 / 96	2.1 / 3.8 GHz	105 MB*	4800 MHz	4 / 16 GT/s	350W	1	0	0	0	512 GB
8468H	48 / 96	2.1 / 3.8 GHz	105 MB*	4800 MHz	4 / 16 GT/s	330W	4	4	4	4	512 GB
8468V	48 / 96	2.4 / 3.8 GHz	97.5 MB*	4800 MHz	3 / 16 GT/s	330W	1	1	1	1	128 GB
8470	52 / 104	2.0 / 3.8 GHz	105 MB*	4800 MHz	4 / 16 GT/s	350W	1	0	0	0	512 GB
8470N	52 / 104	1.7 / 3.6 GHz	97.5 MB	4800 MHz	4 / 16 GT/s	300W	4	4	4	0	128 GB
8471N	52 / 104	1.8 / 3.6 GHz	97.5 MB	4800 MHz	None‡	300W	4	4	4	0	128 GB
8480+	56 / 112	2.0 / 3.8 GHz	105 MB	4800 MHz	4 / 16 GT/s	350W	1	1	1	1	512 GB
8490H	60 / 120	1.9 / 3.5 GHz	112.5 MB	4800 MHz	4 / 16 GT/s	350W	4	4	4	4	512 GB

† The maximum single-core frequency at with the processor is capable of operating

\* L3 cache is 1.875 MB per core or larger. Processors with a larger L3 cache per core are marked with an \*

\*\* Bronze 3408U processor does not support Hyper-Threading Technology

‡ SKUs with a U suffix as well as some other SKUs have no UPI links and are are single-socket only

## One-processor configurations

The SR630 V3 can be used with only one processor installed. Most core functions of the server (including the XClarity Controller) are connected to processor 1 as shown in the [System architecture](#) section.

With only one processor, the server has the following capabilities:

- 16 memory DIMMs for a 2TB maximum
- Two PCIe slots, Slot 1 and Slot 2 are available; Slot 3 is not available
- OCP 3.0 slot
- Up to 4x NVMe front drives using onboard connections
- 7mm drives
- M.2 drives
- Internal RAID adapter or HBA (CFF form factor)

## Thermal requirements by processor

For processors with a TDP of more than 300W, the server must be configured in one of the following two ways:

- Configure the closed-loop liquid-cooled heatsink (feature BRLJ), as described below, or
- Limit the drive backplanes used to only one of the 4-bay front drive backplanes (features BCGB or BPC9 as described in the [Front drive bays](#) section)

For additional thermal requirements for processors, see the Thermal Rules section in the Information Center for the SR630 V3:

[https://pubs.lenovo.com/sr630-v3/thermal\\_rules](https://pubs.lenovo.com/sr630-v3/thermal_rules)

The SR630 V3 supports three different processor heatsink solutions, depending on the configuration, as listed in the following table.

Table 10. Heatsinks

Feature code	Description
BPFK	Standard Heatsink
BP50	Performance Heatsink - ThinkSystem SR630 V3 Neptune Thermal Transfer Module
BRLJ	Closed-loop liquid-cooled heatsink - ThinkSystem SR630 V3 Neptune Liquid to Air Module

The selection of the heatsink will be automatically derived by the configurator and depends on the processor and other components selected. Use the tables in the above Information Center page to determine the requirements for each heatsink.

The closed-loop liquid-cooled heatsink is primarily used for processors with a TDP of more than 300W. The advantage of the closed-loop liquid-cooled solution is that it allows for a higher ambient temperature compared to the performance heatsink.

The following figure shows the placement of the components in the closed-loop liquid-cooled solution. Cold plates are mounted on top of each processor and these are connected via copper tubes to a radiator that is placed in front of the system fans. The liquid is actively pumped through the pipes in a closed loop to remove the heat from the processors.

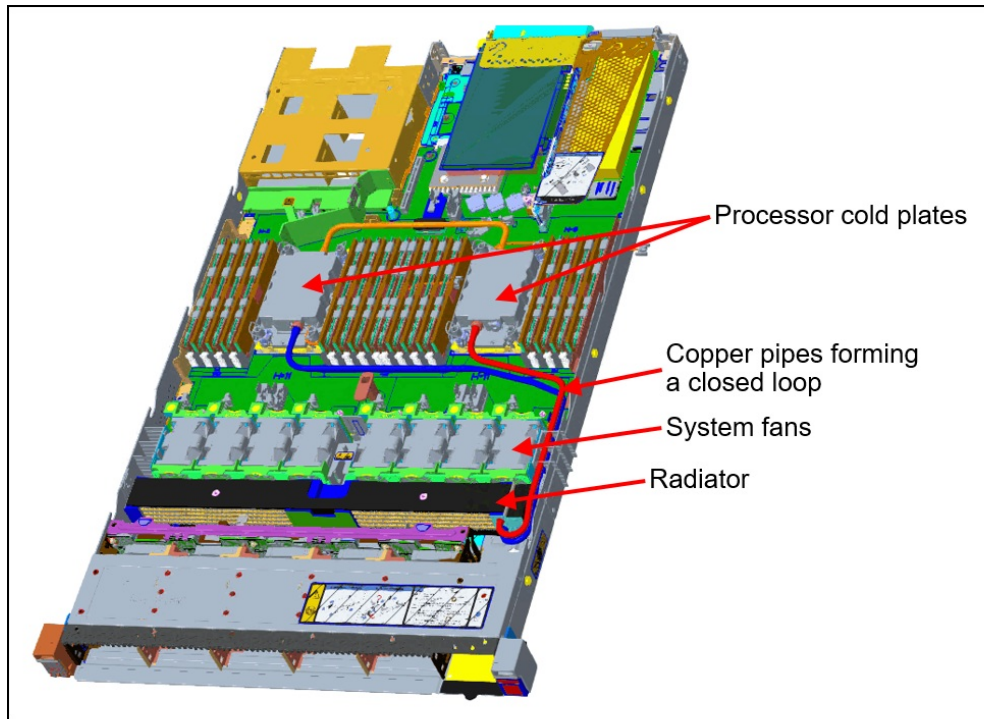

Figure 7. SR630 V3 with closed water loop (feature BRLJ)

The closed-loop liquid-cooled heatsink has the following requirements:

- Either one or two CPUs are supported
- 3.5-inch and EDSFF front drive bays are not supported
- If a RAID 940 or 9350 adapter is configured:
  - RAID supercap must be installed in slot 3
  - 7mm drives are not supported
- The following components are not supported:
  - 256GB 3DS RDIMMs
  - Rear 2.5-inch drives
  - GPUs
  - M.2 drives
  - Any internal RAID/HBAs (CFF form factor)

Additional ambient temperature restrictions may apply. See the [Operating environment](#) section for details.

### UEFI operating modes

The SR630 V3 offers preset operating modes that affect energy consumption and performance. These modes are a collection of predefined low-level UEFI settings that simplify the task of tuning the server to suit your business and workload requirements.

The following table lists the feature codes that allow you to specify the mode you wish to preset in the factory for CTO orders.

Table 11. UEFI operating mode presets in DCSC

Feature code	Description
BFYB	Operating mode selection for: "Maximum Performance Mode"
BFYC	Operating mode selection for: "Minimal Power Mode"
BFYD	Operating mode selection for: "Efficiency Favoring Power Savings Mode"
BFYE	Operating mode selection for: "Efficiency - Favoring Performance Mode"

The preset modes for the SR630 V3 are as follows:

- **Maximum Performance Mode** (feature BFYB): Achieves maximum performance but with higher power consumption and lower energy efficiency.
- **Minimal Power Mode** (feature BFYC): Minimize the absolute power consumption of the system.
- **Efficiency Favoring Power Savings Mode** (feature BFYD): Maximize the performance/watt efficiency with a bias towards power savings. It is expected that will be the favored mode for SPECpower benchmark testing for example.
- **Efficiency Favoring Performance Mode** (feature BFYE): Maximize the performance/watt efficiency with a bias towards performance. It is the favored mode for Energy Star certification for example.

For details about these preset modes, and all other performance and power efficiency UEFI settings offered in the SR630 V3, see the paper "Tuning UEFI Settings for Performance and Energy Efficiency on Intel Xeon Scalable Processor-Based ThinkSystem Servers", available from <https://lenovopress.lenovo.com/lp1477>.

## Memory options

The SR630 V3 uses Lenovo TruDDR5 memory operating at up to 4800 MHz. The server supports up to 32 DIMMs with 2 processors. The processors have 8 memory channels and support 2 DIMMs per channel. The server supports up to 8TB of memory using 32x 256GB 3DS RDIMMs and two processors.

The following table lists the memory options that are available for the server.

Lenovo TruDDR5 memory uses the highest quality components that are sourced from Tier 1 DRAM suppliers and only memory that meets the strict requirements of Lenovo is selected. It is compatibility tested and tuned to maximize performance and reliability. From a service and support standpoint, Lenovo TruDDR5 memory automatically assumes the system warranty, and Lenovo provides service and support worldwide.

Table 12. Memory options

Part number	Feature code	Description
DDR5 9x4 RDIMMs - 4800 MHz		
4X77A77483	BNW5	ThinkSystem 32GB TruDDR5 4800MHz (1Rx4) 9x4 RDIMM
4X77A77033	BKTN	ThinkSystem 64GB TruDDR5 4800MHz (2Rx4) 9x4 RDIMM
DDR5 10x4 RDIMMs - 4800 MHz		
4X77A77029	BKTL	ThinkSystem 16GB TruDDR5 4800MHz (1Rx8) RDIMM
4X77A77030	BNF6	ThinkSystem 32GB TruDDR5 4800MHz (1Rx4) 10x4 RDIMM
4X77A77031	BKTM	ThinkSystem 32GB TruDDR5 4800MHz (2Rx8) RDIMM
4X77A77032	BNF9	ThinkSystem 64GB TruDDR5 4800MHz (2Rx4) 10x4 RDIMM
DDR5 10x4 3DS RDIMMs - 4800 MHz		
4X77A77034	BNFC	ThinkSystem 128GB TruDDR5 4800MHz (4Rx4) 3DS RDIMM
4X77A77035	BNF8	ThinkSystem 256GB TruDDR5 4800MHz (8Rx4) 3DS RDIMM



9x4 RDIMMs (also known as Optimized or EC4 RDIMMs) are a new lower-cost DDR5 memory option supported in ThinkSystem V3 servers. 9x4 DIMMs offer the same performance as standard RDIMMs (known as 10x4 or EC8 modules), however they support lower fault-tolerance characteristics. Standard RDIMMs and 3DS RDIMMs support two 40-bit subchannels (that is, a total of 80 bits), whereas 9x4 RDIMMs support two 36-bit subchannels (a total of 72 bits). The extra bits in the subchannels allow standard RDIMMs and 3DS RDIMMs to support Single Device Data Correction (SDDC), however 9x4 RDIMMs do not support SDDC. Note, however, that all DDR5 DIMMs, including 9x4 RDIMMs, support Bounded Fault correction, which enables the server to correct most common types of DRAM failures.

For more information on DDR5 memory, see the Lenovo Press paper, *Introduction to DDR5 Memory*, available from <https://lenovopress.com/lp1618>.

The following rules apply when selecting the memory configuration:

- The server supports three types of DIMMs: 9x4 RDIMMs, RDIMMs, and 3DS RDIMMs; UDIMMs and LRDIMMs are not supported
- Mixing of DIMM types is not supported (9x4 DIMMs with 10x4 RDIMMs, 9x4 DIMMs with 3DS RDIMMs, 10x4 RDIMMs with 3DS RDIMMs)
- The mixing of 128GB 3DS RDIMMs and 256GB 3DS RDIMMs is supported, however all DIMM slots must be populated evenly: 8x 128GB DIMMs and 8x 256GB DIMMs per processor
- Mixing x4 and x8 DIMMs is not supported
- Mixing of DIMM rank counts is supported. Follow the required installation order installing the DIMMs with the higher rank counts first.
- Mixing of DIMM capacities is supported, however only two different capacities are supported across all channels of the processor (eg 16GB and 32GB). Follow the required installation order installing the larger DIMMs first.

For best performance, consider the following:

- Ensure the memory installed is at least the same speed as the memory bus of the selected processor.
- Populate all 8 memory channels.

The following memory protection technologies are supported:

- ECC detection/correction
- Bounded Fault detection/correction
- SDDC (for x4-based memory DIMMs; look for "x4" in the DIMM description)
- ADDDC (for 10x4-based memory DIMMs, not supported with 9x4 DIMMs)
- Memory mirroring

**Note:** Memory sparing is not supported

If memory channel mirroring is used, then DIMMs must be installed in pairs (minimum of one pair per processor), and both DIMMs in the pair must be identical in type and size. 50% of the installed capacity is available to the operating system. Memory rank sparing is not supported.

## Internal storage

The SR630 V3 supports 4x 3.5-inch or 12x 2.5-inch or 16x EDSFF drive bays, depending on the selected chassis and backplane configuration. The server also supports configurations without any drive bays if desired.

The server supports front and rear drive bays, are as follows:

- Front:
  - 4x 3.5-inch hot-swap bays, or
  - Up to 10x 2.5-inch hot-swap bays, or
  - 16x EDSFF hot-swap bays
- Rear:
  - 2x 2.5-inch hot-swap bays, or
  - 2x 7mm hot-swap drives bays

All drives are hot-swap and are accessible from the front or from the rear.

The server also supports one or two M.2 drives, installed in an M.2 adapter internal to the server.

In this section:

- [NVMe drive support](#)
- [Front drive bays](#)
- [Rear 2.5-inch and 7mm drive bays](#)
- [Storage configurations](#)
- [Field upgrades](#)
- [RAID flash power module \(supercap\) support](#)
- [M.2 drives](#)
- [SED encryption key management with ISKLM](#)

### NVMe drive support

The SR630 V3 supports NVMe drives to maximize storage performance:

- In 2.5-inch front drive configurations, the server supports up to 12 NVMe drives without oversubscription (that is, each x4 drive has a dedicated x4 connection (4 lanes) to the processor):
  - 10x 2.5-inch NVMe drives at the front
  - 2x 2.5-inch NVMe drives at the rear
- In 3.5-inch front drive configurations, the server supports up to 6 NVMe drives without oversubscription:
  - 4x 3.5-inch NVMe drives at the front
  - 2x 2.5-inch NVMe drives at the rear
- In EDSFF front drive configurations, the server supports up to 16 NVMe drives without oversubscription:
  - 16x E1.S NVMe drives at the front

The specifics of these configurations are covered in the [Storage configurations](#) section.

In addition, the SR630 V3 supports two 7mm NVMe drives for use as boot drives. These two drives optionally support RAID via a separate RAID adapter installed in a PCIe slot.

The RAID 940-8i and RAID 940-16i adapters also support NVMe through a feature named Tri-Mode support (or Trimode support). This feature enables the use of NVMe U.3 drives at the same time as SAS and SATA drives. Cabling of the controller to the backplanes is the same as with SAS/SATA drives, and the NVMe drives are connected via a PCIe x1 link to the controller.

NVMe drives connected using Tri-Mode support provide better performance than SAS or SATA drives: A SATA SSD has a data rate of 6Gbps, a SAS SSD has a data rate of 12Gbps, whereas an NVMe U.3 Gen 4 SSD with a PCIe x1 link will have a data rate of 16Gbps. NVMe drives typically also have lower latency and higher IOPS compared to SAS and SATA drives. Tri-Mode is supported with U.3 NVMe drives in either 2.5-inch and 3.5-inch form factor and requires an AnyBay backplane.

**Tri-Mode requires U.3 drives:** Only NVMe drives with a U.3 interface are supported. U.2 drives are not supported. See the [Internal drive options](#) section for the U.3 drives supported by the server.

## Front drive bays

The front drive bay zone supports the following configurations. All drives are hot-swap.

- 3.5-inch hot-swap drive bays
  - 4x SAS/SATA 3.5-inch
  - 4x AnyBay 3.5-inch (PCIe Gen4)
- 2.5-inch hot-swap drive bays - 4 drive bays
  - 4x SAS/SATA
  - 4x NVMe (PCIe Gen4)
- 2.5-inch hot-swap drive bays - 8 drive bays
  - 8x SAS/SATA
- 2.5-inch hot-swap drive bays - 10 drive bays
  - 10x SAS/SATA
  - 6x SAS/SATA + 4x AnyBay (PCIe Gen4 or Gen5)
  - 6x SAS/SATA + 4x NVMe (PCIe Gen4)
  - 6x SAS/SATA + 2x AnyBay + 2x NVMe (PCIe Gen4 or Gen5)
  - 10x AnyBay (PCIe Gen4 or Gen5)
  - 10x NVMe (PCIe Gen4 or Gen5)
- EDSFF drive bays
  - 16x E1.S (9.5mm or 15mm) hot-swap NVMe drive bays (PCIe Gen4)
- Drive-less 2.5-inch configuration - No backplane and no drives (supports [field upgrades](#))
- Drive-less 3.5-inch configuration - No backplane and no drives (supports [field upgrades](#))

These configurations are shown in the following two figures. The feature codes listed correspond to the feature codes listed in the table below the figures.

The following figure shows the supported 3.5-inch and EDSFF drive bay configurations. EDSFF drive configurations can be configured with or without an Integrated Diagnostics Panel with pull-out LCD display. See the [Local management](#) section for details.

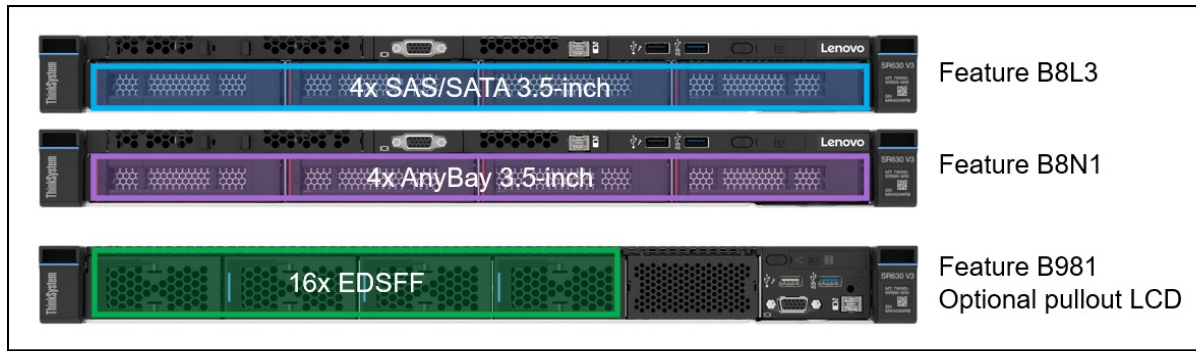

Figure 8. SR630 V3 front drive bay configurations - 3.5-inch and EDSFF drive bays

The following figure shows the supported 2.5-inch drive bay configurations:

- 4x 2.5-inch drive configurations can be configured with or without front PCIe slots. Front slots are mutually exclusive with rear slots. See the [I/O expansion](#) for details.
- 8x 2.5-inch drive configurations can be configured with or without an Integrated Diagnostics Panel with pull-out LCD display. See the [Local management](#) section for details.

**Front PCIe slots:** Support for Front PCIe slots is planned for 2Q/2023.

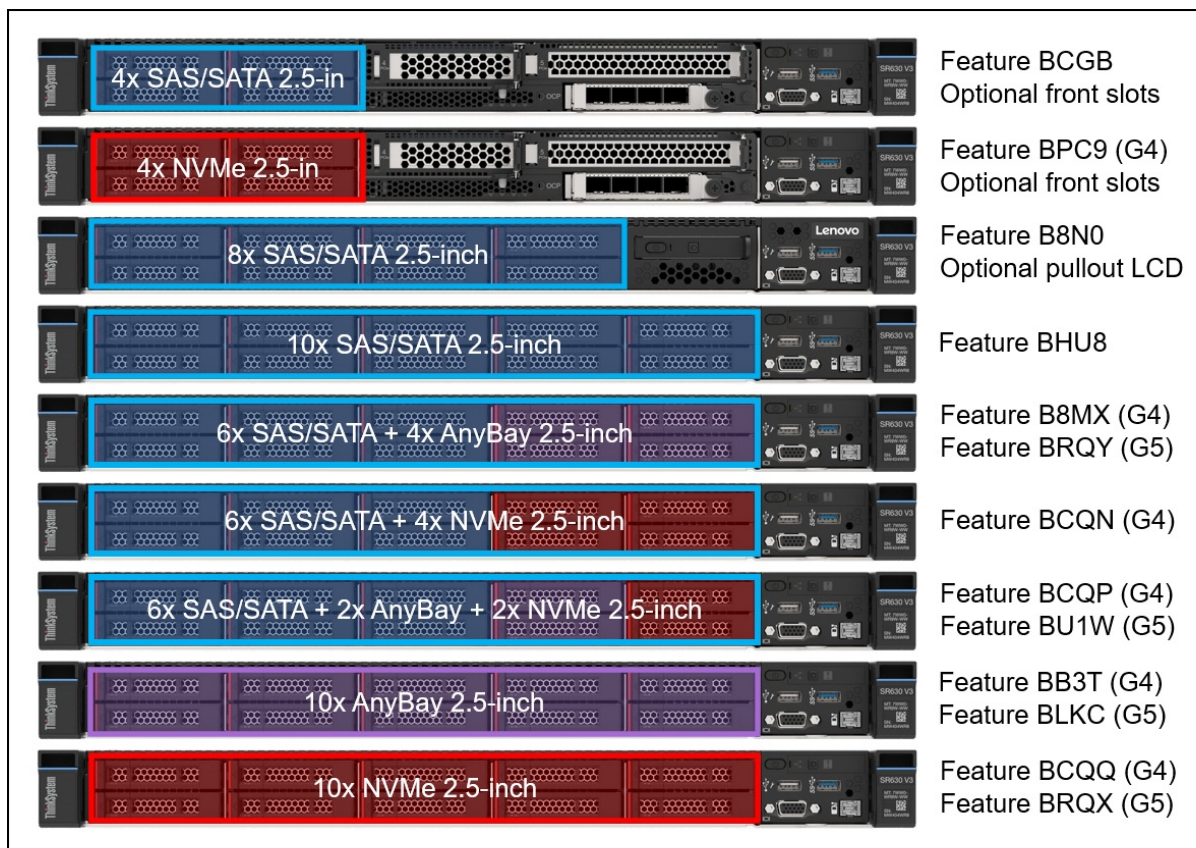

Figure 9. SR630 V3 front drive bay configurations - 2.5-inch drive bays

The backplanes used to provide these drive bays are listed in the following table.

**Field upgrades:** Most front backplanes are available as part numbers for field upgrades using upgrade kits, as described in the [Field upgrades](#) section below.

Table 13. Backplanes for front drive bays

Feature code	Description	PCIe Gen	Maximum supported
Front 2.5-inch drive backplanes - 4 drive bays			
BCGB	ThinkSystem 1U 4x2.5" SAS/SATA Backplane	-	1
BPC9	ThinkSystem 1U 4x 2.5" NVMe Gen 4 Backplane	Gen4	1
Front 2.5-inch drive backplanes - 8 drive bays			
B8N0	ThinkSystem 1U 8x2.5" SAS/SATA Backplane	-	1
Front 2.5-inch drive backplanes - 10 drive bays			
BHU8	ThinkSystem 1U 10x2.5" SAS/SATA Backplane	-	1
B8MX	ThinkSystem 1U 10x2.5" (6x SAS/SATA 4x AnyBay) Backplane	Gen4	1
BRQY	ThinkSystem 1U 2.5" 6 SAS/SATA 4 AnyBay Gen5 Backplane	Gen5	1
BCQN	ThinkSystem 1U 2.5" 6 SAS/SATA 4 NVMe Backplane	Gen4	1
BCQP	ThinkSystem 1U 10x2.5" (6x SAS/SATA 2x AnyBay 2x NVMe) Backplane	Gen4	1
BU1W	ThinkSystem 1U 10x2.5" (6x SAS/SATA 2x AnyBay 2x NVMe) Gen5 Backplane	Gen5	1
BB3T	ThinkSystem 1U 10x2.5" AnyBay Backplane	Gen4	1
BLKC	ThinkSystem 1U 10x2.5" AnyBay Gen5 Backplane	Gen5	1
BCQQ	ThinkSystem 1U 10x2.5" NVMe Backplane	Gen4	1
BRQX	ThinkSystem 1U 2.5" 10 NVMe Gen5 Backplane	Gen5	1
Front 3.5-inch drive backplanes			
B8L3	ThinkSystem 1U/2U 4x3.5" SAS/SATA Backplane	-	1
B8N1	ThinkSystem 1U 4x3.5" AnyBay Backplane	Gen4	1
Front EDSFF drive backplanes			
B981	ThinkSystem 1U 16xEDSFF Backplane	Gen4	1

## Rear 2.5-inch and 7mm drive bays

The SR630 V3 supports hot-swap drives installed at the rear of the server chassis. Supported configurations are as follows:

- 2x 2.5-inch hot-swap SAS/SATA drive bays
- 2x 2.5-inch hot-swap NVMe drive bays (PCIe Gen 4)
- 2x 7mm SAS/SATA drive bays
- 2x 7mm NVMe drive bays (PCIe Gen 4)

The configurations are shown in the following figure.

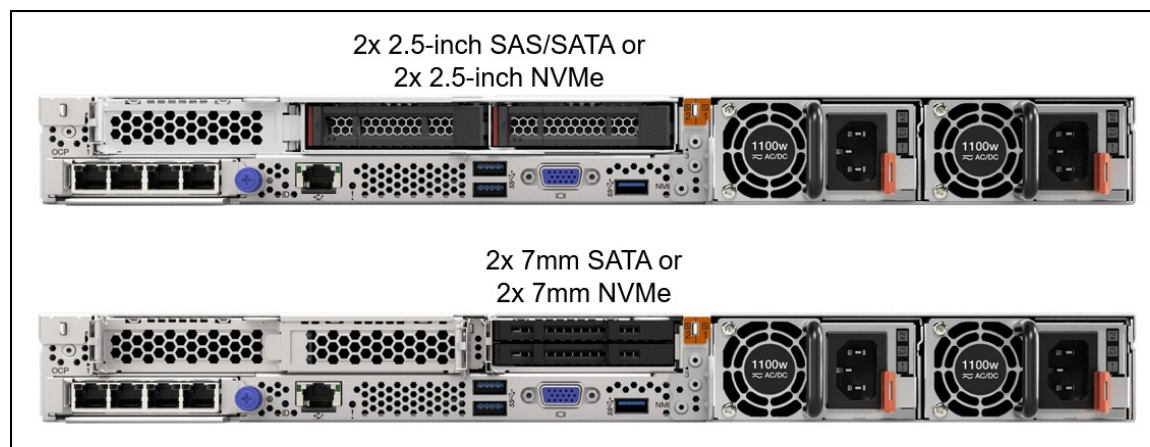

Figure 10. Rear drive bay configurations

The backplanes used to provide these drive bays in CTO orders are listed in the following table. Backplanes are also available as part numbers for field upgrades using upgrade kits, as described in the [Field upgrades](#) section below.

Table 14. Backplanes for rear drive bays

Feature code	Description	Maximum supported
Rear - 2.5-inch drive backplanes		
B8MY	ThinkSystem 1U 2x2.5" SAS/SATA Rear Backplane	1
BDY6	ThinkSystem 1U 2x2.5" NVMe Rear Backplane	1
Rear - 7mm drive backplane		
BU0N	ThinkSystem 7mm SATA/NVMe 2-Bay Rear Enablement Kit v2	1
VROC for 7mm drives (optional, for RAID support)		
BS7U	On Board SATA Software RAID Mode for 7mm	
BS7R	Intel VROC (VMD NVMe RAID) Standard for 7mm	
Controllers for RAID support of 7mm drives (optional; an alternative to VROC)		
BVL2	ThinkSystem Raid 5350-8i for 7MM SATA boot Enablement	1
BVL4	ThinkSystem Raid 540-8i for 7MM NVMe boot Enablement	1

The use of rear 2.5-inch drive bays has the following configuration rules:

- With 2.5-inch rear drive bays, only slot 1 is available. Slot 2 and 3 are not available
- GPUs are not supported

The use of the 7mm rear drive bays has the following configuration rules:

- The 7mm drive bays support either SATA drives or NVMe drives but not both. You specify SATA or NVMe in the configurator using feature codes BTTV (SATA) or BTTW (NVMe).
- 7mm rear drive bays occupy slot 3; slots 1 and 2 are available and slot 2 is a low profile slot. Slot 3 is not available.
- RAID support is implemented using VROC (no adapter needed) or with the use of an additional RAID adapter installed in a slot
- If RAID is enabled using VROC, select these feature codes:
  - VROC SATA support: On Board SATA Software RAID Mode for 7mm (feature BS7U)
  - VROC NVMe support: Intel VROC (VMD NVMe RAID) Standard for 7mm (feature BS7R)
- If RAID is enabled using a RAID adapter, the adapter is installed in PCIe slot 1 or 2:
  - RAID support for 7mm SATA drives requires a RAID 5350-8i adapter (feature BVL2)
  - RAID support for 7mm NVMe drives requires a RAID 540-8i adapter operating in Tri-Mode (feature BVL4)
- GPUs are not supported
- M.2 and 7mm drives are mutually exclusive: they are not supported together in the same configuration

**Field upgrades:** Rear backplanes are available as part numbers for field upgrades using upgrade kits, as described in the [Field upgrades](#) section below.

## Storage configurations

This section describes the various combinations of front and rear drives that the server supports, as well as M.2 support.

In this section:

- [Overview of configurations](#)
- [Details - Configurations with 3.5-inch front drive bays](#)
- [Details - Configurations with 2.5-inch front drive bays](#)

**Front PCIe slots:** Support for front PCIe slots is planned for 2Q/2023.

## Overview of configurations

The following tables summarize the storage configurations for the SR630 V3. For details, including processor requirements, M.2 and 7mm support, and controller selections, see the [Storage configurations - Details](#) section.

### Storage configurations - 3.5-inch front drives

Table 15. Storage configurations - 3.5-inch front drives

Config	Total drives (NVMe)	Front				Rear		Backplanes
		SAS/SATA	Any Bay	NVMe	EDSFF	2.5" SAS	2.5" NVMe	
1	4 (0)	4	0	0	0	0	0	4x3.5" SAS/SATA (B8L3)
2	6 (2)	4	0	0	0	0	2	Front: 4x3.5" SAS/SATA (B8L3); Rear: 2x 2.5" NVMe (BDY6)
3	6 (0)	4	0	0	0	2	0	Front: 4x3.5" SAS/SATA (B8L3); Rear: 2x 2.5" SAS/SATA (B8MY)
4	4 (0)	4	0	0	0	0	0	4x3.5" SAS/SATA (B8L3)
5	4 (4)	0	4	0	0	0	0	4x3.5" AnyBay (B8N1)
6	6 (6)	0	4	0	0	0	2	Front: 4x3.5" AnyBay (B8N1); Rear: 2x 2.5" NVMe (BDY6)
7	6 (4)	0	4	0	0	2	0	Front: 4x3.5" AnyBay (B8N1); Rear: 2x 2.5" SAS/SATA (B8MY)
8	4 (4)	0	4	0	0	0	0	4x3.5" AnyBay (B8N1)
30	4 (4)	0	4	0	0	0	0	4x3.5" AnyBay (B8N1)

**Storage configurations - 2.5-inch front drives**

Table 16. Storage configurations - 2.5-inch front drives

Config	Total drives (NVMe)	Front				Rear		Backplanes
		SAS/SATA	Any Bay	NVMe	EDSFF	2.5" SAS	2.5" NVMe	
9	10 (4)	6	4	0	0	0	0	6xS/S + 4xAnyB (B8MX)
10	12 (6)	6	4	0	0	0	2	Front: 6xS/S + 4xAnyB (B8MX); Rear: 2x 2.5" NVMe (BDY6)
10B	12 (4)	6	4	0	0	2	0	Front: 6xS/S + 4xAnyB (B8MX); Rear: 2x 2.5" SAS/SATA (B8MY)
10C	10 (4)	6	4	0	0	0	0	6xS/S + 4xAnyB (B8MX)
12	10 (4)	6	2	2	0	0	0	6xS/S + 2xAnyB + 2xNVMe (BCQP)
12A	10 (4)	6	2	2	0	0	0	6xS/S + 2xAnyB + 2xNVMe (BCQP)
13	10 (0)	10	0	0	0	0	0	10x SAS/SATA (BHU8)
14	12 (0)	10	0	0	0	2	0	Front: 10x SAS/SATA (BHU8); Rear: 2x 2.5" SAS/SATA (B8MY)
15	12 (2)	10	0	0	0	0	2	Front: 10x SAS/SATA (BHU8); Rear: 2x 2.5" NVMe (BDY6)
16	10 (0)	10	0	0	0	0	0	10x SAS/SATA (BHU8)
18	10 (10)	0	10	0	0	0	0	10x2.5" AnyBay (BB3T)
19	12 (12)	0	10	0	0	0	2	Front: 10x2.5" AnyBay (BB3T); Rear: 2x 2.5" NVMe (BDY6)
21	10 (10)	0	10	0	0	0	0	10x2.5" AnyBay (BB3T)
22	8 (0)	8	0	0	0	0	0	8x2.5" SAS/SATA (B8N0)
23	10 (0)	8	0	0	0	2	0	Front: 8x2.5" SAS/SATA (B8N0); Rear: 2x 2.5" SAS/SATA (B8MY)
24	8 (0)	8	0	0	0	0	0	8x2.5" SAS/SATA (B8N0)
25	16 (16)	0	0	0	16	0	0	16xEDSFF (B981)
26	4 (0)	4	0	0	0	0	0	4x2.5" SAS/SATA (BCGB)
27	4 (0)	4	0	0	0	0	0	4x2.5" SAS/SATA (BCGB)
28	10 (10)	0	0	10	0	0	0	10x2.5" NVMe (BCQQ)



Config	Total drives (NVMe)	Front				Rear		Backplanes
		SAS/SATA	Any Bay	NVMe	EDSFF	2.5" SAS	2.5" NVMe	
29	8 (8)	0	8	0	0	0	0	TBD
31	4 (4)	0	0	4	0	0	0	4x 2.5" NVMe (BPC9)
31A	4 (4)	0	0	4	0	0	0	4x 2.5" NVMe (BPC9)
32	10 (0)	10	0	0	0	0	0	10x SAS/SATA (BHU8)
32A	10 (0)	10	0	0	0	0	0	10x SAS/SATA (BHU8)
32	10 (0)	10	0	0	0	0	0	10x SAS/SATA (BHU8)
32A	10 (0)	10	0	0	0	0	0	10x SAS/SATA (BHU8)
32	10 (0)	10	0	0	0	0	0	10x SAS/SATA (BHU8)
32A	10 (0)	10	0	0	0	0	0	10x SAS/SATA (BHU8)
32	10 (0)	10	0	0	0	0	0	10x SAS/SATA (BHU8)
32A	10 (0)	10	0	0	0	0	0	10x SAS/SATA (BHU8)
32	10 (0)	10	0	0	0	0	0	10x SAS/SATA (BHU8)
32A	10 (0)	10	0	0	0	0	0	10x SAS/SATA (BHU8)
33	10 (4)	6	4	0	0	0	0	6xS/S + 4xAnyB (B8MX)
33A	10 (4)	6	4	0	0	0	0	6xS/S + 4xAnyB (B8MX)
33	10 (4)	6	4	0	0	0	0	6xS/S + 4xAnyB (B8MX)
33A	10 (4)	6	4	0	0	0	0	6xS/S + 4xAnyB (B8MX)
33	10 (4)	6	4	0	0	0	0	6xS/S + 4xAnyB (B8MX)
33A	10 (4)	6	4	0	0	0	0	6xS/S + 4xAnyB (B8MX)
34	10 (4)	6	2	2	0	0	0	6xS/S + 2xAnyB + 2xNVMe (BCQP)
34A	10 (4)	6	2	2	0	0	0	6xS/S + 2xAnyB + 2xNVMe (BCQP)
34	10 (4)	6	2	2	0	0	0	6xS/S + 2xAnyB + 2xNVMe (BCQP)
34A	10 (4)	6	2	2	0	0	0	6xS/S + 2xAnyB + 2xNVMe (BCQP)
34	10 (4)	6	2	2	0	0	0	6xS/S + 2xAnyB + 2xNVMe (BCQP)
34A	10 (4)	6	2	2	0	0	0	6xS/S + 2xAnyB + 2xNVMe (BCQP)
35	8 (0)	8	0	0	0	0	0	8x2.5" SAS/SATA (B8N0)
35A	8 (0)	8	0	0	0	0	0	8x2.5" SAS/SATA (B8N0)
35	8 (0)	8	0	0	0	0	0	8x2.5" SAS/SATA (B8N0)
35A	8 (0)	8	0	0	0	0	0	8x2.5" SAS/SATA (B8N0)
35	8 (0)	8	0	0	0	0	0	8x2.5" SAS/SATA (B8N0)
35A	8 (0)	8	0	0	0	0	0	8x2.5" SAS/SATA (B8N0)
35	8 (0)	8	0	0	0	0	0	8x2.5" SAS/SATA (B8N0)
35A	8 (0)	8	0	0	0	0	0	8x2.5" SAS/SATA (B8N0)
35	8 (0)	8	0	0	0	0	0	8x2.5" SAS/SATA (B8N0)
35A	8 (0)	8	0	0	0	0	0	8x2.5" SAS/SATA (B8N0)
36	10 (10)	0	0	10	0	0	0	10x2.5" NVMe (BCQQ)
36A	10 (10)	0	0	10	0	0	0	10x2.5" NVMe (BCQQ)
37	8 (8)	0	0	8	0	0	0	TBD
37A	8 (8)	0	0	8	0	0	0	TBD
41	10 (10)	0	10	0	0	0	0	10x2.5" AnyBay G5 (BLKC)
41A	10 (10)	0	10	0	0	0	0	10x2.5" AnyBay G5 (BLKC)
41	10 (10)	0	10	0	0	0	0	10x2.5" AnyBay G5 (BLKC)
41A	10 (10)	0	10	0	0	0	0	10x2.5" AnyBay G5 (BLKC)
41	10 (10)	0	10	0	0	0	0	10x2.5" AnyBay G5 (BLKC)

Config	Total drives (NVMe)	Front				Rear		Backplanes
		SAS/SATA	Any Bay	NVMe	EDSFF	2.5" SAS	2.5" NVMe	
41A	10 (10)	0	10	0	0	0	0	10x2.5" AnyBay G5 (BLKC)
41	10 (10)	0	10	0	0	0	0	10x2.5" AnyBay G5 (BLKC)
41A	10 (10)	0	10	0	0	0	0	10x2.5" AnyBay G5 (BLKC)
41	10 (10)	0	10	0	0	0	0	10x2.5" AnyBay G5 (BLKC)
41A	10 (10)	0	10	0	0	0	0	10x2.5" AnyBay G5 (BLKC)
42	10 (4)	6	4	0	0	0	0	6xS/S + 4xAnyB G5 (BRQY)
42A	10 (4)	6	4	0	0	0	0	6xS/S + 4xAnyB G5 (BRQY)
42	10 (4)	6	4	0	0	0	0	6xS/S + 4xAnyB G5 (BRQY)
42A	10 (4)	6	4	0	0	0	0	6xS/S + 4xAnyB G5 (BRQY)
42	10 (4)	6	4	0	0	0	0	6xS/S + 4xAnyB G5 (BRQY)
42A	10 (4)	6	4	0	0	0	0	6xS/S + 4xAnyB G5 (BRQY)
42	10 (4)	6	4	0	0	0	0	6xS/S + 4xAnyB G5 (BRQY)
42A	10 (4)	6	4	0	0	0	0	6xS/S + 4xAnyB G5 (BRQY)
43	10 (4)	6	2	2	0	0	0	6xS/S + 2xAnyB + 2xNVMe G5 (BU1W)
43A	10 (4)	6	2	2	0	0	0	6xS/S + 2xAnyB + 2xNVMe G5 (BU1W)
43	10 (4)	6	2	2	0	0	0	6xS/S + 2xAnyB + 2xNVMe G5 (BU1W)
43A	10 (4)	6	2	2	0	0	0	6xS/S + 2xAnyB + 2xNVMe G5 (BU1W)
43	10 (4)	6	2	2	0	0	0	6xS/S + 2xAnyB + 2xNVMe G5 (BU1W)
43A	10 (4)	6	2	2	0	0	0	6xS/S + 2xAnyB + 2xNVMe G5 (BU1W)
43	10 (4)	6	2	2	0	0	0	6xS/S + 2xAnyB + 2xNVMe G5 (BU1W)
43A	10 (4)	6	2	2	0	0	0	6xS/S + 2xAnyB + 2xNVMe G5 (BU1W)
43	10 (4)	6	2	2	0	0	0	6xS/S + 2xAnyB + 2xNVMe G5 (BU1W)
43A	10 (4)	6	2	2	0	0	0	6xS/S + 2xAnyB + 2xNVMe G5 (BU1W)
43	10 (4)	6	2	2	0	0	0	6xS/S + 2xAnyB + 2xNVMe G5 (BU1W)
43A	10 (4)	6	2	2	0	0	0	6xS/S + 2xAnyB + 2xNVMe G5 (BU1W)
43	10 (4)	6	2	2	0	0	0	6xS/S + 2xAnyB + 2xNVMe G5 (BU1W)
43A	10 (4)	6	2	2	0	0	0	6xS/S + 2xAnyB + 2xNVMe G5 (BU1W)
44	10 (10)	0	0	10	0	0	0	10x2.5" NVMe G5 (BRQX)
44A	10 (10)	0	0	10	0	0	0	10x2.5" NVMe G5 (BRQX)
46	8 (8)	0	0	8	0	0	0	TBD
46A	8 (8)	0	0	8	0	0	0	TBD
47	8 (8)	0	8	0	0	0	0	TBD
47A	8 (8)	0	8	0	0	0	0	TBD

### Details - 3.5-inch front bays

Table 17. Details - 3.5-inch front bays

Config	CPUs	Front				Rear		Backplanes	7mm	M.2 x4	Supported controllers
		SAS/SATA	Any Bay	NVMe	EDSFF	2.5" SAS	2.5" NVMe				
1-1	1 or 2	4	0	0	0	0	0	4x3.5" SAS/SATA (B8L3)	N	N	OB SATA
1-2	1 or 2								N	N	(5350-8i or 9350-8i)
1-3	1 or 2								N	N	4350-8i

Config	CPUs	Front				Rear		Backplanes	7 <sup>th</sup>	M.	Supported controllers
		SAS/SATA	Any Bay	NVMe	EDSFF	2.5" SAS	2.5" NVMe				
1-4	1 or 2								N	N	(940-8i or 540-8i)
1-5	1 or 2								N	N	440-8i
2-1	2 only	4	0	0	0	0	2	Front: 4x3.5" SAS/SATA (B8L3); Rear: 2x 2.5" NVMe (BDY6)	N	N	Front: OB SATA; Rear: OB NVMe
2-2	2 only								N	N	Front: (5350-8i or 9350-8i); Rear: OB NVMe
2-3	2 only								N	N	Front: 4350-8i; Rear: OB NVMe
2-4	2 only								N	N	Front: (940-8i or 540-8i); Rear: OB NVMe
2-5	2 only								N	N	Front: 440-8i; Rear: OB NVMe
3-1	1 or 2								4	0	0
3-2	1 or 2	N	N	(5350-8i or 9350-8i)							
3-3	1 or 2	N	N	4350-8i							
3-4	1 or 2	N	N	(940-8i or 540-8i)							
3-5	1 or 2	N	N	440-8i							
4-1	1 or 2	4	0	0	0	0	0	4x3.5" SAS/SATA (B8L3)	Y	N	OB SATA
4-2	1 or 2								Y	N	(5350-8i or 9350-8i)
4-3	1 or 2								Y	N	4350-8i
4-4	1 or 2								Y	N	(940-8i or 540-8i)
4-5	1 or 2								Y	N	440-8i
5-1	1 or 2	0	4	0	0	0	0	4x3.5" AnyBay (B8N1)	N	N	OB SATA
5-2	1 or 2								N	N	(5350-8i or 9350-8i)
5-3	1 or 2								N	N	4350-8i
5-4	1 or 2								N	N	(940-8i or 540-8i)
5-5	1 or 2								N	N	440-8i
5-6	1 or 2								N	N	9350-16i
5-7	1 or 2								N	N	(540-16i or 940-16i)
6-1	2 only	0	4	0	0	0	2	Front: 4x3.5" AnyBay (B8N1); Rear: 2x 2.5" NVMe (BDY6)	N	N	Front: OB SATA + OB NVMe; Rear: OB NVMe
6-2	2 only								N	N	Front: (5350-8i or 9350-8i) + OB NVMe; Rear: OB NVMe
6-3	2 only								N	N	Front: 4350-8i + OB NVMe; Rear: OB NVMe
6-4	2 only								N	N	Front: (940-8i or 540-8i) + OB NVMe; Rear: OB NVMe
6-5	2 only								N	N	Front: 440-8i + OB NVMe; Rear: OB NVMe
6-6	2 only								N	N	Front: 9350-16i + OB NVMe; Rear: OB NVMe
6-7	2 only								N	N	Front: (540-16i or 940-16i) + OB NVMe; Rear: OB NVMe
7-1	1 or 2	0	4	0	0	2	0	Front: 4x3.5" AnyBay (B8N1); Rear: 2x 2.5" SAS/SATA (B8MY)	N	N	OB SATA + OB NVMe
7-2	1 or 2								N	N	(5350-8i or 9350-8i) + OB NVMe
7-3	1 or 2								N	N	4350-8i + OB NVMe
7-4	1 or 2								N	N	(940-8i or 540-8i) + OB NVMe

Config	CPUs	Front				Rear		Backplanes	7mm	M.2	Supported controllers
		SAS/SATA	Any Bay	NVMe	EDSFF	2.5" SAS	2.5" NVMe				
7-5	1 or 2								N	N	440-8i + OB NVMe
7-6	1 or 2								N	N	9350-16i + OB NVMe
7-7	1 or 2								N	N	(540-16i or 940-16i) + OB NVMe
8-1	1 or 2	0	4	0	0	0	0	4x3.5" AnyBay (B8N1)	Y*	N	OB SATA + OB NVMe
8-2	1 or 2								Y*	N	(5350-8i or 9350-8i) + OB NVMe
8-3	1 or 2								Y*	N	4350-8i + OB NVMe
8-4	1 or 2								Y*	N	(940-8i or 540-8i) + OB NVMe
8-5	1 or 2								Y*	N	440-8i + OB NVMe
8-6	1 or 2								Y*	N	9350-16i + OB NVMe
8-7	1 or 2								Y*	N	(540-16i or 940-16i) + OB NVMe
30-1	1 or 2	0	4	0	0	0	0	4x3.5" AnyBay (B8N1)	N	N	940-8i Tri-mode

\* For M.2 and 7mm: With only 1 processor installed, only SATA is supported; NVMe is not supported

### Details - 2.5-inch front bays

Table 18. Details - 2.5-inch front bays

Config	CPUs	Front				Rear		Backplanes	7mm	M.2 x4	Supported controllers
		SAS/SATA	Any Bay	NVMe	EDSFF	2.5" SAS	2.5" NVMe				
9-1	1 or 2	6	4	0	0	0	0	6xS/S + 4xAnyB (B8MX)	N	Y*	9350-16i + OB NVMe
9-2	1 or 2								N	Y*	4350-16i + OB NVMe
9-3	1 or 2								N	Y*	(540-16i or 940-16i) + OB NVMe
9-4	1 or 2								N	Y*	440-16i + OB NVMe
9-5	2 only								N	Y	9350-16i CFF + OB NVMe
9-6	2 only								N	Y	940-16i CFF + OB NVMe
9-7	2 only								N	Y	440-16i CFF + OB NVMe
9-8	1 or 2								N	Y*	OB SATA + OB NVMe
10-1	2 only	6	4	0	0	0	2	Front: 6xS/S + 4xAnyB (B8MX); Rear: 2x 2.5" NVMe (BDY6)	N	Y	Front: 9350-16i + OB NVMe; Rear: OB NVMe
10-2	2 only								N	Y	Front: 4350-16i + OB NVMe; Rear: OB NVMe
10-3	2 only								N	Y	Front: (540-16i or 940-16i) + OB NVMe; Rear: OB NVMe
10-4	2 only								N	Y	Front: 440-16i + OB NVMe; Rear: OB NVMe
10-5	2 only								N	Y	Front: 9350-16i CFF + OB NVMe; Rear: OB NVMe
10-6	2 only								N	Y	Front: 940-16i CFF + OB NVMe; Rear: OB NVMe
10-7	2 only								N	Y	Front: 440-16i CFF + OB NVMe; Rear: OB NVMe

Config	CPUs	Front				Rear		Backplanes	7m	M.	Supported controllers
		SAS/SATA	Any Bay	NVMe	EDSFF	2.5" SAS	2.5" NVMe				
10-8	2 only								N	Y	OB SATA + OB NVMe
10B-1	1 or 2	6	4	0	0	2	0	Front: 6xS/S + 4xAnyB (B8MX); Rear: 2x 2.5" SAS/SATA (B8MY)	N	Y*	9350-16i + OB NVMe
10B-2	1 or 2								N	Y*	4350-16i + OB NVMe
10B-3	1 or 2								N	Y*	(540-16i or 940-16i) + OB NVMe
10B-4	1 or 2								N	Y*	440-16i + OB NVMe
10B-5	2 only								N	Y	9350-16i CFF + OB NVMe
10B-6	2 only								N	Y	940-16i CFF + OB NVMe
10B-7	2 only								N	Y	440-16i CFF + OB NVMe
10C-1	1 or 2								6	4	0
10C-2	1 or 2	Y*	N	4350-16i + OB NVMe							
10C-3	1 or 2	Y*	N	(540-16i or 940-16i) + OB NVMe							
10C-4	1 or 2	Y*	N	440-16i + OB NVMe							
10C-5	2 only	Y	N	9350-16i CFF + OB NVMe							
10C-6	2 only	Y	N	940-16i CFF + OB NVMe							
10C-7	2 only	Y	N	440-16i CFF + OB NVMe							
10C-8	1 or 2	Y*	N	OB SATA							
12-1	1 or 2	6	2	2	0	0	0	6xS/S + 2xAnyB + 2xNVMe (BCQP)	N	Y	OB SATA + OB NVMe
12-2	1 or 2								N	Y	(5350-8i or 9350-8i or 9350-16i) + OB NVMe
12-3	1 or 2								N	Y	(4350-8i or 4350-16i) + OB NVMe
12-4	1 or 2								N	Y	(940-8i or 540-8i or 540-16i) + OB NVMe
12-5	1 or 2								N	Y	(440-8i or 440-16i) + OB NVMe
12-6	2 only								N	Y	(5350-8i CFF or 9350-8i CFF or 9350-16i CFF) + OB NVMe
12-7	2 only								N	Y	940-16i CFF + OB NVMe
12-8	2 only								N	Y	440-16i CFF + OB NVMe
12A-1	1 or 2	6	2	2	0	0	0	6xS/S + 2xAnyB + 2xNVMe (BCQP)	Y*	N	OB SATA + OB NVMe
12A-2	1 or 2								Y*	N	(5350-8i or 9350-8i or 9350-16i) + OB NVMe
12A-3	1 or 2								Y*	N	(4350-8i or 4350-16i) + OB NVMe
12A-4	1 or 2								Y*	N	(940-8i or 540-8i or 540-16i) + OB NVMe
12A-5	1 or 2								Y*	N	(440-8i or 440-16i) + OB NVMe
12A-6	2 only								Y	N	(5350-8i CFF or 9350-8i CFF or 9350-16i CFF)
12A-7	2 only								Y	N	940-16i CFF
12A-8	2 only								Y	N	440-16i CFF
13-1	1 or 2	10	0	0	0	0	0	10x SAS/SATA (BHU8)	N	Y	OB SATA
13-2	1 or 2								N	Y	9350-16i

Config	CPUs	Front				Rear		Backplanes	7m	M.	Supported controllers						
		SAS/SATA	Any Bay	NVMe	EDSFF	2.5" SAS	2.5" NVMe										
13-3	1 or 2							N	Y	4350-16i							
13-4	1 or 2							N	Y	(540-16i or 940-16i)							
13-5	1 or 2							N	Y	440-16i							
13-6	2 only							N	Y	9350-16i CFF							
13-7	2 only							N	Y	940-16i CFF							
13-8	2 only							N	Y	440-16i CFF							
13-9	1 only							N	Y	9350-16i CFF							
13-10	1 only							N	Y	940-16i CFF							
13-11	1 only							N	Y	440-16i CFF							
14-2	1 or 2							10	0	0	0	2	0	Front: 10x SAS/SATA (BHU8); Rear: 2x 2.5" SAS/SATA (B8MY)	N	Y	9350-16i
14-3	1 or 2														N	Y	4350-16i
14-4	1 or 2	N	Y	(940-16i or 540-16i)													
14-5	1 or 2	N	Y	440-16i													
14-6	2 only	N	Y	9350-16i CFF													
14-7	2 only	N	Y	940-16i CFF													
14-8	2 only	N	Y	440-16i CFF													
14-9	1 only	N	Y	9350-16i CFF													
14-10	1 only	N	Y	940-16i CFF													
14-11	1 only	N	Y	440-16i CFF													
15-1	2 only	10	0	0	0	0	2								Front: 10x SAS/SATA (BHU8); Rear: 2x 2.5" NVMe (BDY6)	N	Y
15-2	2 only							N	Y	Front: 9350-16i; Rear: OB NVMe							
15-3	2 only							N	Y	Front: 4350-16i; Rear: OB NVMe							
15-4	2 only							N	Y	Front: (540-16i or 940-16i); Rear: OB NVMe							
15-5	2 only							N	Y	Front: 440-16i; Rear: OB NVMe							
15-6	2 only							N	Y	Front: 9350-16i CFF; Rear: OB NVMe							
15-7	2 only							N	Y	Front: 940-16i CFF; Rear: OB NVMe							
15-8	2 only							N	Y	Front: 440-16i CFF; Rear: OB NVMe							
15-9	1 only							N	Y (SATA)	Front: 9350-16i CFF; Rear: OB NVMe							
15-10	1 only							N	Y (SATA)	Front: 940-16i CFF; Rear: OB NVMe							
15-11	1 only							N	Y (SATA)	Front: 440-16i CFF; Rear: OB NVMe							
16-1	1 or 2	10	0	0	0	0	0	10x SAS/SATA (BHU8)	Y	N	OB SATA						
16-2	1 or 2								Y	N	9350-16i						
16-3	1 or 2								Y	N	9350-16i						
16-4	1 or 2								Y	N	(940-16i or 540-16i)						
16-5	1 or 2								Y	N	440-16i						
16-6	1 or 2								Y	N	940-16i CFF						
16-7	1 or 2								Y	N	440-16i CFF						

Config	CPUs	Front				Rear		Backplanes	7m	M.	Supported controllers
		SAS/SATA	Any Bay	NVMe	EDSFF	2.5" SAS	2.5" NVMe				
16-8	1 or 2								Y	N	9350-16i CFF
16-9	1 only								Y	N	940-16i CFF
16-10	1 only								Y	N	440-16i CFF
16-11	1 only								Y	N	9350-16i CFF
18-1	2 only	0	10	0	0	0	0	10x2.5" AnyBay (BB3T)	N	Y	9350-16i + OB NVMe
18-2	2 only								N	Y	9350-16i + OB NVMe
18-3	2 only								N	Y	(940-16i or 540-16i) + OB NVMe
18-4	2 only								N	Y	440-16i + OB NVMe
19-1	2 only	0	10	0	0	0	2	Front: 10x2.5" AnyBay (BB3T); Rear: 2x 2.5" NVMe (BDY6)	N	Y	Front: 9350-16i + OB NVMe; Rear: OB NVMe
19-2	2 only								N	Y	Front: 9350-16i + OB NVMe; Rear: OB NVMe
19-3	2 only								N	Y	Front: (940-16i or 540-16i) + OB NVMe; Rear: OB NVMe
19-4	2 only								N	Y	Front: 440-16i + OB NVMe; Rear: OB NVMe
21-1	2 only	0	10	0	0	0	0	10x2.5" AnyBay (BB3T)	Y	N	9350-16i + OB NVMe
21-2	2 only								Y	N	9350-16i + OB NVMe
21-3	2 only								Y	N	(940-16i or 540-16i) + OB NVMe
21-4	2 only								Y	N	440-16i + OB NVMe
22-1	1 or 2	8	0	0	0	0	0	8x2.5" SAS/SATA (B8N0)	N	Y	OB SATA
22-2	1 or 2								N	Y	(5350-8i or 9350-8i)
22-3	1 or 2								N	Y	4350-8i
22-4	1 or 2								N	Y	(940-8i or 540-8i)
22-5	1 or 2								N	Y	440-8i
22-6	1 or 2								N	Y	9350-16i
22-7	1 or 2								N	Y	(540-16i or 940-16i)
22-8	1 or 2								N	Y	(5350-8i CFF or 9350-8i CFF or 9350-16i CFF)
22-9	1 or 2								N	Y	940-16i CFF
22-10	1 or 2								N	Y	440-16i CFF
22-12	1 only								N	Y	(9350-8i or 9350-16i)
22-13	1 only	N	Y	940-16i CFF							
22-11	1 only	N	Y	440-16i CFF							
23-1	1 or 2	8	0	0	0	2	0	Front: 8x2.5" SAS/SATA (B8N0); Rear: 2x 2.5" SAS/SATA (B8MY)	N	Y	OB SATA
23-2	1 or 2								N	Y	Front: (5350-8i or 9350-8i); Rear: OB SATA
23-3	1 or 2								N	Y	Front: 4350-8i; Rear: OB SATA
23-4	1 or 2								N	Y	Front: (940-8i or 540-8i); Rear: OB SATA
23-5	1 or 2								N	Y	Front: 440-8i; Rear: OB SATA
23-6	2 only								N	Y	9350-16i CFF

Config	CPUs	Front				Rear		Backplanes	7m	M.	Supported controllers	
		SAS/SATA	Any Bay	NVMe	EDSFF	2.5" SAS	2.5" NVMe					
23-7	2 only									N	Y	940-16i CFF
23-8	2 only									N	Y	440-16i CFF
23-9	2 only									N	Y	<b>Front:</b> (5350-8i CFF or 9350-8i CFF); <b>Rear:</b> OB SATA
23-10	1 only									N	Y	<b>Front:</b> (5350-8i CFF or 9350-8i CFF); <b>Rear:</b> OB SATA
23-11	1 only									N	Y	9350-16i CFF
23-12	1 only									N	Y	940-16i CFF
23-13	1 only									N	Y	440-16i CFF
24-1	1 or 2	8	0	0	0	0	0	8x2.5" SAS/SATA (B8N0)	Y	N	OB SATA	
24-2	1 or 2										(5350-8i or 9350-8i)	
24-3	1 or 2										4350-8i	
24-4	1 or 2										(940-8i or 540-8i)	
24-5	1 or 2										440-8i	
24-6	2 only										(5350-8i CFF or 9350-8i CFF or 9350-16i CFF)	
24-7	2 only										940-16i CFF	
24-8	2 only										440-16i CFF	
24-9	1 only										(5350-8i CFF or 9350-8i CFF or 9350-16i CFF)	
24-10	1 only										940-16i CFF	
24-11	1 only										440-16i CFF	
25-1	2 only	0	0	0	16	0	0	16xEDSFF (B981)	N	N	Retimer + OB NVMe	
26-1	1 or 2	4	0	0	0	0	0	4x2.5" SAS/SATA (BCGB)	Y	N	OB SATA	
26-2	1 or 2										(5350-8i or 9350-8i)	
26-3	1 or 2										4350-8i	
26-4	1 or 2										(940-8i or 540-8i)	
26-5	1 or 2										440-8i	
27-1	1 or 2	4	0	0	0	0	0	4x2.5" SAS/SATA (BCGB)	N	Y	OB SATA	
27-2	1 or 2										(5350-8i or 9350-8i)	
27-3	1 or 2										4350-8i	
27-4	1 or 2										(940-8i or 540-8i)	
27-5	1 or 2										440-8i	
28-1	2 only	0	0	10	0	0	0	10x2.5" NVMe (BCQQ)	N	N	OB NVMe	
28-2	2 only										<b>Front:</b> OB NVMe; <b>Rear:</b> OB SATA	
28-3	2 only										<b>Front:</b> OB NVMe; <b>Rear:</b> OB NVMe	
28-4	2 only										OB NVMe	
29-1	1 or 2	0	8	0	0	0	0	TBD	N	N	940-8i Tri-mode	
31-1	2 only	0	0	4	0	0	0	4x 2.5" NVMe (BPC9)	N	Y	OB NVMe	
31-2	2 only										<b>Front:</b> OB NVMe; <b>Rear:</b> OB SATA	
31-3	2 only										OB NVMe	



Config	CPUs	Front				Rear		Backplanes	7th	M.	Supported controllers
		SAS/SATA	Any Bay	NVMe	EDSFF	2.5" SAS	2.5" NVMe				
31-4	2 only								N	Y	Front: OB NVMe; Rear: OB NVMe
31A-1	1 only	0	0	4	0	0	0	4x 2.5" NVMe (BPC9)	N	Y (SATA)	OB NVMe
31A-2	1 only								N	Y (SATA)	Front: OB NVMe; Rear: OB SATA
31A-3	1 only								Y	N	OB NVMe
31A-4	1 only								N	Y	Retimer
31A-5	1 only								Y	N	Retimer
32-1	1 or 2	10	0	0	0	0	0	10x SAS/SATA (BHU8)	N	N	OB SATA
32A-1	1 or 2	10	0	0	0	0	0	10x SAS/SATA (BHU8)	Y	N	OB SATA
32-2	1 or 2	10	0	0	0	0	0	10x SAS/SATA (BHU8)	N	N	(5350-16i or 9350-16i)
32A-2	1 or 2	10	0	0	0	0	0	10x SAS/SATA (BHU8)	Y	N	(5350-16i or 9350-16i)
32-3	1 or 2	10	0	0	0	0	0	10x SAS/SATA (BHU8)	N	N	4350-16i
32A-3	1 or 2	10	0	0	0	0	0	10x SAS/SATA (BHU8)	Y	N	4350-16i
32-4	1 or 2	10	0	0	0	0	0	10x SAS/SATA (BHU8)	N	N	(540-16i or 940-16i)
32A-4	1 or 2	10	0	0	0	0	0	10x SAS/SATA (BHU8)	Y	N	(540-16i or 940-16i)
32-5	1 or 2	10	0	0	0	0	0	10x SAS/SATA (BHU8)	N	N	440-16i
32A-5	1 or 2	10	0	0	0	0	0	10x SAS/SATA (BHU8)	Y	N	440-16i
33-1	1 or 2	6	4	0	0	0	0	6xS/S + 4xAnyB (B8MX)	N	N	OB SATA + OB NVMe
33A-1	1 or 2	6	4	0	0	0	0	6xS/S + 4xAnyB (B8MX)	Y*	N	OB SATA + OB NVMe
33-2	1 or 2	6	4	0	0	0	0	6xS/S + 4xAnyB (B8MX)	N	N	(9350-16i or 4350-16i) + OB NVMe
33A-2	1 or 2	6	4	0	0	0	0	6xS/S + 4xAnyB (B8MX)	Y*	N	(9350-16i or 4350-16i) + OB NVMe
33-3	1 or 2	6	4	0	0	0	0	6xS/S + 4xAnyB (B8MX)	N	N	(940-16i or 540-16i or 440-16i) + OB NVMe
33A-3	1 or 2	6	4	0	0	0	0	6xS/S + 4xAnyB (B8MX)	Y*	N	(940-16i or 540-16i or 440-16i) + OB NVMe
34-1	1 or 2	6	2	2	0	0	0	6xS/S + 2xAnyB + 2xNVMe (BCQP)	N	N	OB SATA + OB NVMe
34A-1	1 or 2	6	2	2	0	0	0	6xS/S + 2xAnyB + 2xNVMe (BCQP)	Y*	N	OB SATA + OB NVMe
34-2	1 or 2	6	2	2	0	0	0	6xS/S + 2xAnyB + 2xNVMe (BCQP)	N	N	(5350-8i or 9350-8i or 9350-16i or 4350-8i or 4350-16i) + OB NVMe
34A-2	1 or 2	6	2	2	0	0	0	6xS/S + 2xAnyB + 2xNVMe (BCQP)	Y*	N	(5350-8i or 9350-8i or 9350-16i or 4350-8i or 4350-16i) + OB NVMe

Config	CPUs	Front				Rear		Backplanes	7 <sup>th</sup>	M.	Supported controllers
		SAS/SATA	Any Bay	NVMe	EDSFF	2.5" SAS	2.5" NVMe				
34-3	1 or 2	6	2	2	0	0	0	6xS/S + 2xAnyB + 2xNVMe (BCQP)	N	N	(940-8i or 940-16i or 540-8i or 540-16i or 440-8i or 440-16i) + OB NVMe
34A-3	1 or 2	6	2	2	0	0	0	6xS/S + 2xAnyB + 2xNVMe (BCQP)	Y*	N	(940-8i or 940-16i or 540-8i or 540-16i or 440-8i or 440-16i) + OB NVMe
35-1	1 or 2	8	0	0	0	0	0	8x2.5" SAS/SATA (B8N0)	N	N	OB SATA
35A-1	1 or 2	8	0	0	0	0	0	8x2.5" SAS/SATA (B8N0)	Y	N	OB SATA
35-2	1 or 2	8	0	0	0	0	0	8x2.5" SAS/SATA (B8N0)	N	N	(5350-8i or 9350-8i)
35A-2	1 or 2	8	0	0	0	0	0	8x2.5" SAS/SATA (B8N0)	Y	N	(5350-8i or 9350-8i)
35-3	1 or 2	8	0	0	0	0	0	8x2.5" SAS/SATA (B8N0)	N	N	4350-8i
35A-3	1 or 2	8	0	0	0	0	0	8x2.5" SAS/SATA (B8N0)	Y	N	4350-8i
35-4	1 or 2	8	0	0	0	0	0	8x2.5" SAS/SATA (B8N0)	N	N	(940-8i or 540-8i)
35A-4	1 or 2	8	0	0	0	0	0	8x2.5" SAS/SATA (B8N0)	Y	N	(940-8i or 540-8i)
35-5	1 or 2	8	0	0	0	0	0	8x2.5" SAS/SATA (B8N0)	N	N	440-8i
35A-5	1 or 2	8	0	0	0	0	0	8x2.5" SAS/SATA (B8N0)	Y	N	440-8i
36-1	2 only	0	0	10	0	0	0	10x2.5" NVMe (BCQQ)	N	N	OB NVMe
36A-1	2 only	0	0	10	0	0	0	10x2.5" NVMe (BCQQ)	Y	N	OB NVMe
37-1	1 only	0	0	8	0	0	0	TBD	N	N	Retimer + OB NVMe
37A-1	1 only	0	0	8	0	0	0	TBD	Y	N	Retimer + OB NVMe
41-1	2 only	0	10	0	0	0	0	10x2.5" AnyBay G5 (BLKC)	N	Y	OB SATA + OB NVMe
41A-1	2 only	0	10	0	0	0	0	10x2.5" AnyBay G5 (BLKC)	Y	N	OB SATA + OB NVMe
41-2	2 only	0	10	0	0	0	0	10x2.5" AnyBay G5 (BLKC)	N	Y	(5350-16i or 9350-16i) + OB NVMe
41A-2	2 only	0	10	0	0	0	0	10x2.5" AnyBay G5 (BLKC)	Y	N	(5350-16i or 9350-16i) + OB NVMe
41-3	2 only	0	10	0	0	0	0	10x2.5" AnyBay G5 (BLKC)	N	Y	4350-16i + OB NVMe
41A-3	2 only	0	10	0	0	0	0	10x2.5" AnyBay G5 (BLKC)	Y	N	4350-16i + OB NVMe
41-4	2 only	0	10	0	0	0	0	10x2.5" AnyBay G5 (BLKC)	N	Y	(940-16i or 540-16i) + OB NVMe
41A-4	2 only	0	10	0	0	0	0	10x2.5" AnyBay G5 (BLKC)	Y	N	(940-16i or 540-16i) + OB NVMe
41-5	2 only	0	10	0	0	0	0	10x2.5" AnyBay G5 (BLKC)	N	Y	440-16i + OB NVMe
41A-5	2 only	0	10	0	0	0	0	10x2.5" AnyBay G5 (BLKC)	Y	N	440-16i + OB NVMe

Config	CPUs	Front				Rear		Backplanes	7 <sup>m</sup>	M.	Supported controllers
		SAS/SATA	Any Bay	NVMe	EDSFF	2.5" SAS	2.5" NVMe				
42-1	2 only	6	4	0	0	0	0	6xS/S + 4xAnyB G5 (BRQY)	N	Y	9350-16i CFF + OB NVMe
42A-1	2 only	6	4	0	0	0	0	6xS/S + 4xAnyB G5 (BRQY)	Y	N	9350-16i CFF
42-2	2 only	6	4	0	0	0	0	6xS/S + 4xAnyB G5 (BRQY)	N	Y	940-16i CFF
42A-2	2 only	6	4	0	0	0	0	6xS/S + 4xAnyB G5 (BRQY)	Y	N	940-16i CFF
42-3	2 only	6	4	0	0	0	0	6xS/S + 4xAnyB G5 (BRQY)	N	Y	440-16i CFF
42A-3	2 only	6	4	0	0	0	0	6xS/S + 4xAnyB G5 (BRQY)	Y	N	440-16i CFF
42-4	1 or 2	6	4	0	0	0	0	6xS/S + 4xAnyB G5 (BRQY)	N	Y*	9350-16i
42-5	1 or 2								N	Y*	(940-16i or 540-16i)
42-6	1 or 2								N	Y*	4350-16i
42-7	1 or 2								N	Y*	440-16i
42-8	1 or 2								N	Y*	OB SATA
42A-4	1 or 2	6	4	0	0	0	0	6xS/S + 4xAnyB G5 (BRQY)	Y*	N	9350-16i
42A-5	1 or 2								Y*	N	(940-16i or 540-16i)
42A-6	1 or 2								Y*	N	4350-16i
42A-7	1 or 2								Y*	N	440-16i
42A-8	1 or 2								Y*	N	OB SATA
43-1	1 or 2	6	2	2	0	0	0	6xS/S + 2xAnyB + 2xNVMe G5 (BU1W)	N	Y*	(5350-8i or 9350-8i or 9350-16i)
43A-1	1 or 2	6	2	2	0	0	0	6xS/S + 2xAnyB + 2xNVMe G5 (BU1W)	Y*	N	(5350-8i or 9350-8i or 9350-16i)
43-2	1 or 2	6	2	2	0	0	0	6xS/S + 2xAnyB + 2xNVMe G5 (BU1W)	N	Y*	(940-8i or 940-16i or 540-8i or 540-16i)
43A-2	1 or 2	6	2	2	0	0	0	6xS/S + 2xAnyB + 2xNVMe G5 (BU1W)	Y*	N	(940-8i or 940-16i or 540-8i or 540-16i)
43-3	1 or 2	6	2	2	0	0	0	6xS/S + 2xAnyB + 2xNVMe G5 (BU1W)	N	Y*	(4350-8i or 4350-16i)
43A-3	1 or 2	6	2	2	0	0	0	6xS/S + 2xAnyB + 2xNVMe G5 (BU1W)	Y*	N	(4350-8i or 4350-16i)
43-4	1 or 2	6	2	2	0	0	0	6xS/S + 2xAnyB + 2xNVMe G5 (BU1W)	N	Y*	(440-8i or 440-16i)
43A-4	1 or 2	6	2	2	0	0	0	6xS/S + 2xAnyB + 2xNVMe G5 (BU1W)	Y*	N	(440-8i or 440-16i)
43-5	1 or 2	6	2	2	0	0	0	6xS/S + 2xAnyB + 2xNVMe G5 (BU1W)	N	Y*	OB SATA
43A-5	1 or 2	6	2	2	0	0	0	6xS/S + 2xAnyB + 2xNVMe G5 (BU1W)	Y*	N	OB SATA

Config	CPUs	Front				Rear		Backplanes	7m	M.	Supported controllers
		SAS/SATA	Any Bay	NVMe	EDSFF	2.5" SAS	2.5" NVMe				
43-6	2 only	6	2	2	0	0	0	6xS/S + 2xAnyB + 2xNVMe G5 (BU1W)	N	Y	(5350-8i CFF or 9350-8i CFF or 9350-16i CFF)
43A-6	2 only	6	2	2	0	0	0	6xS/S + 2xAnyB + 2xNVMe G5 (BU1W)	Y	N	(5350-8i CFF or 9350-8i CFF or 9350-16i CFF)
43-7	2 only	6	2	2	0	0	0	6xS/S + 2xAnyB + 2xNVMe G5 (BU1W)	N	Y	940-16i CFF
43A-7	2 only	6	2	2	0	0	0	6xS/S + 2xAnyB + 2xNVMe G5 (BU1W)	Y	N	940-16i CFF
43-8	2 only	6	2	2	0	0	0	6xS/S + 2xAnyB + 2xNVMe G5 (BU1W)	N	Y	440-16i CFF
43A-8	2 only	6	2	2	0	0	0	6xS/S + 2xAnyB + 2xNVMe G5 (BU1W)	Y	N	440-16i CFF
44-1	2 only	0	0	10	0	0	0	10x2.5" NVMe G5 (BRQX)	N	Y	OB NVMe
44A-1	2 only	0	0	10	0	0	0	10x2.5" NVMe G5 (BRQX)	Y	N	OB NVMe
46-1	1 only	0	0	8	0	0	0	TBD	N	Y (SATA)	Retimer + OB NVMe
46A-1	1 only	0	0	8	0	0	0	TBD	Y	N	Retimer + OB NVMe
47-1	1 only	0	8	0	0	0	0	TBD	N	Y (SATA)	OB SATA + OB NVMe + Retimer
47A-1	1 only	0	8	0	0	0	0	TBD	Y	N	OB SATA + OB NVMe + Retimer

\* For M.2 and 7mm: With only 1 processor installed, only SATA is supported; NVMe is not supported

## Field upgrades

The SR630 V3 is orderable without drive bays, allowing you to add a backplane, cabling and controllers as field upgrades. The following table summarizes the option part numbers you will need to order for each available drive configuration.

Configuration rules:

- For front drive bays, backplane kits do not include cables. Cables must be ordered separately.
- For Rear drive bays, backplane kits included cables.
- There is no upgrade path to add drive bays if the SR630 V3 already has a backplane, without removing the existing backplane. For example, you cannot upgrade an 8x 2.5-inch drive bay to 10 bays without first removing the existing backplane.
- EDSFF configurations are CTO only. There are no field upgrades to EDSFF drives.

The following table lists the backplane option kits. Cables are ordered separately for front backplanes.

Table 19. Backplane option kits

Part number	Description
Front drive bays - 3.5-inch (cables must be ordered separately)	
4XH7A83854	ThinkSystem V3 1U 4x3.5" SAS/SATA Backplane Option Kit
4XH7A83853	ThinkSystem V3 1U 4x3.5" AnyBay Backplane Option Kit
Front drive bays - 2.5-inch (cables must be ordered separately)	
4XH7A83855	ThinkSystem V3 1U 4x2.5" SAS/SATA Backplane Option Kit
4XH7A83852	ThinkSystem V3 1U 4x2.5" NVMe Backplane Option Kit
4XH7A83850	ThinkSystem V3 1U 8x2.5" SAS/SATA Backplane Option Kit
4XH7A83858	ThinkSystem V3 1U 10x2.5" SAS/SATA Backplane Option Kit
4XH7A83851	ThinkSystem SR630 V3 10x2.5" Gen5 AnyBay Backplane Option Kit
4XH7A83859	ThinkSystem V3 1U 10x2.5" AnyBay Backplane Option Kit
4XH7A83856	ThinkSystem V3 1U 6x2.5" SAS/SATA+ 4xAnyBay Backplane Option Kit
4XH7A87140	ThinkSystem SR630 V3 1U 6x2.5" SAS/SATA+ 4 Gen5 AnyBay Backplane Option Kit
4XH7A87141	ThinkSystem SR630 V3 1U 6x2.5" SAS/SATA+2 Gen5 NVMe+ 2 Gen5 AnyBay Gen5 Backplane Option Kit
Rear drive bays (cables included)	
4XH7A83860	ThinkSystem V3 1U 2x2.5" SAS/SATA Backplane Option Kit
4XH7A83861	ThinkSystem V3 1U Rear 2x2.5" NVMe Backplane Option Kit

The following table lists the backplane cables kits.

Table 20. Cable kit part numbers

Part number	Description
Cable kits for 3.5-inch front backplanes	
4X97A83824	ThinkSystem SR630 V3 4x3.5" SAS/SATA Backplane Cable Kit
4X97A83825	ThinkSystem SR630 V3 4x3.5" AnyBay Backplane SAS/SATA Cable Kit
4X97A83826	ThinkSystem SR630 V3 4x3.5" AnyBay Backplane NVMe Cable kit
Cable kits for 2.5-inch front backplanes	
4X97A85031	ThinkSystem SR630 V3 PCIe Gen4 x16 Retimer Cable Kit
4X97A83836	ThinkSystem SR630 V3 4x2.5" SAS/SATA Backplane Cable Kit
4X97A85012	ThinkSystem SR630 V3 4x2.5" NVMe Backplane Cable Kit
4X97A83828	ThinkSystem SR630 V3 8x2.5" SAS/SATA Backplane Cable Kit
4X97A83835	ThinkSystem SR630 V3 10x2.5" SAS/SATA Backplane Cable Kit
4X97A83829	ThinkSystem SR630 V3 10x2.5" AnyBay Backplane NVMe Cable Kit
4X97A87134	ThinkSystem SR630 V3 6xSAS/SATA+4xAnyBay Backplane NVMe Cable Kit
4X97A83830	ThinkSystem SR630 V3 10x2.5" AnyBay Backplane SAS/SATA Cable Kit
4X97A83833	ThinkSystem SR630 V3 6xSAS/SATA+4xAnyBay Backplane SAS/SATA Cable Kit
4X97A87135	ThinkSystem SR630 V3 10x2.5" Gen5 AnyBay Backplane NVMe Cable Kit
4X97A87136	ThinkSystem SR630 V3 10x2.5" Gen5 AnyBay Backplane SAS/SATA Cable Kit

When adding drive bays, you will also need to add the appropriate storage controller(s). Consult the tables in the [Storage configurations](#) section to determine what controller sections are supported and what additional controllers you will need. Controllers are described in the [Controllers for internal storage](#) section.

### Upgrades to Internal (CFF) RAID adapter

It is also supported to upgrade a server from an onboard SATA controller to an internal (CFF) RAID adapter or CFF HBA, without changing any backplanes. In addition to ordering the storage adapter, you will also need to order the cable kit listed in the following table.

Table 21. Cable needed for field upgrades to add CFF adapter

Part number	Description
4X97A87137	ThinkSystem SR630 V3 Internal Raid Adapter Cable Kit

### 7mm drive bay upgrades

For field upgrades to add 7mm drive bays, order the part number listed in the following table.

**HW RAID support:** The 7mm Enablement Kit part numbers below do not include the RAID adapter optionally used for 7mm HW RAID support. If you wish to enable hardware RAID support for 7mm, you will need to order either the 5350-8i for SATA RAID support or 540-8i for NVMe RAID support. In addition, the 540-8i, once installed, will need to be configured to operate in Tri-mode to enable NVMe RAID.

Table 22. Field upgrades for 7mm drives

Part number	Description	Purpose
<b>7mm Drive Enablement Kits</b>		
4XH7A83862	ThinkSystem SR630 V3 7mm SATA/NVMe 2-Bay Non-Raid Enablement Kit <ul style="list-style-type: none"> <li>7mm drive cage</li> <li>7mm drive backplane with cables for onboard connections</li> <li>2x drive bay fillers</li> </ul>	7mm drive bays for onboard SATA or NVMe drive support (does not include cables needed for RAID support)
TBD	ThinkSystem SR630 V3 Rear 2x7mm SATA/NVMe RAID Enablement Kit <ul style="list-style-type: none"> <li>7mm drive cage</li> <li>7mm drive backplane</li> <li>2x drive bay fillers</li> <li>Cables for connectivity to 540-8i or 9350-8i RAID adapter</li> </ul>	7mm drive bays for SATA or NVMe drives, plus cables for use with a RAID adapter
<b>RAID adapters for optional 7mm HW RAID support</b>		
4Y37A72482	ThinkSystem RAID 5350-8i PCIe 12Gb Adapter	RAID adapter needed for SATA RAID-1 with 2x 7mm SATA drives
4Y37A78834	ThinkSystem RAID 540-8i PCIe Gen4 12Gb Adapter	RAID adapter needed for NVMe RAID-1 with 2x 7mm NVMe drives

### RAID flash power module (supercap) support

If you plan to add one of the RAID adapters that includes a RAID flash power module (supercap) as a field upgrade, then you will also need to order a Supercap installation kit for the power module. For CTO orders, the components in the installation kit are automatically derived when you select the RAID adapter.

The adapters that this applies to are as follows:

- Any supported RAID 9350 adapter
- Any supported RAID 940 adapter

There are up to three possible locations for supercaps, depending on the front drive bays (2.5-inch or 3.5-inch) and the type of the processor heatsinks. Details are summarized in the following table. Location references are shown in the figure below.

Table 23. Supercap support

Front drive configuration	Processor heatsinks	Number of adapters & supercaps	Location of supercaps
2.5-inch	Standard	3	1. Front of server behind operator panel ❶ 2. Mounted on air baffle ❷ 3. Mounted on air baffle ❷
	High Performance	1	1. Front of server behind operator panel ❶
	Closed-loop liquid	1	1. Installed in slot 3 attached to Riser 2 ❸
3.5-inch	Standard	2	1. Mounted on air baffle ❷ 2. Mounted on air baffle ❷
	High Performance	1	1. Installed in slot 3 attached to Riser 2 ❸

The locations where supercaps are installed is shown in the following figure.

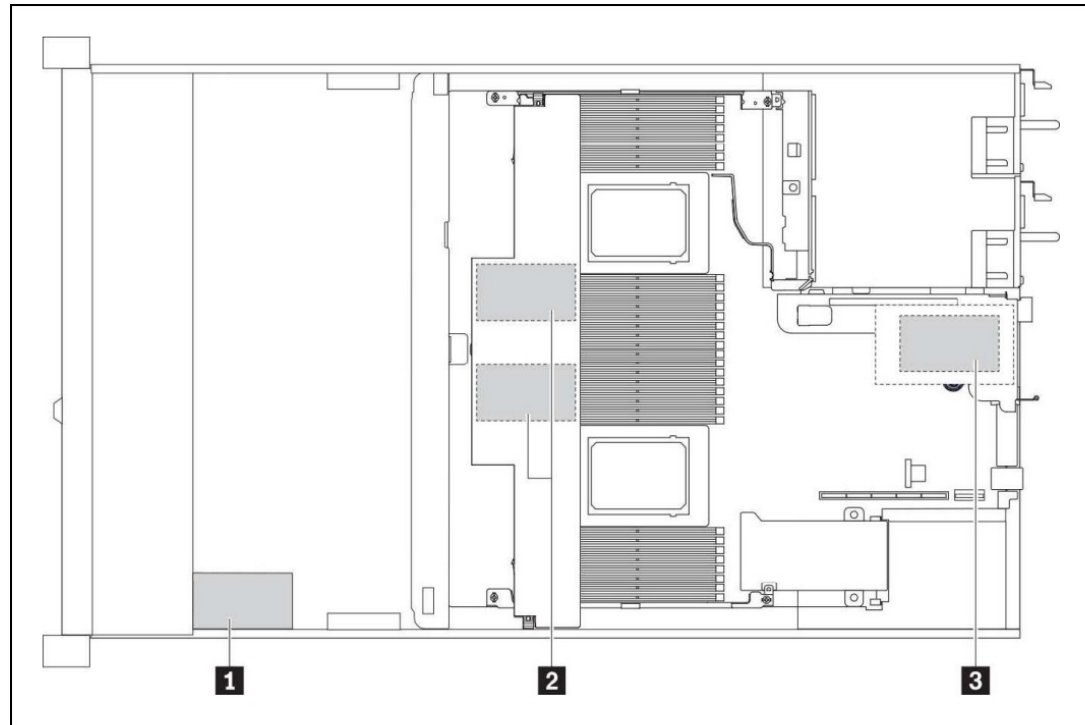

Figure 11. Location of the supercaps in the SR630 V3

When adding a RAID adapter and supercap as a field upgrade, order the supercap installation kit list listed in the following table.

Table 24. RAID Flash Power Module installation kits

Part number	Feature code	Description	Maximum supported
4M17A61304	BK70	ThinkSystem V2/V3 1U Supercap Holder Kit (For use in position ❶ at the front of the server)	1
4XF7A85032	BK5T	ThinkSystem SR645 V3/SR635 V3 Supercap Holder Kit for PCIe Slot (Low profile adapter form factor for use in slot 3, position ❸)	1

## M.2 drives

The SR630 V3 supports one or two M.2 form-factor SATA or NVMe drives for use as an operating system boot solution or as additional storage.

The M.2 drives install into an M.2 module which is mounted horizontally in the server in front of the fans as shown in the [Internal view](#) of the server. In configurations with 2.5-inch front drive bays, the M.2 module is position between the drive bays and the fans. In configurations with 3.5-inch front drive bays, the M.2 module is mounted on top of the front drive bays.

The supported M.2 module is listed in the following table. For field upgrades see the [M.2 field upgrades](#) section below.

Table 25. M.2 modules

Part number	Feature code	Description	SATA drives	NVMe drives	RAID	Maximum supported
4Y37A79663	BM8X	ThinkSystem M.2 SATA/x4 NVMe 2-Bay Enablement Kit	Yes	Yes (x4 lanes)	VROC	1

The M.2 adapter optionally supports RAID with the addition of either VROC or a separate RAID adapter. For CTO orders, ordering information is listed in the following table.

Table 26. CTO feature codes to select M.2 RAID

Feature code	Description	RAID support	Maximum supported
VROC for M.2 drives (optional, for RAID support)			
BS7Q	On Board SATA Software RAID Mode for M.2	SATA	1
BS7M	Intel VROC (VMD NVMe RAID) Standard for M.2	NVMe	1
Controllers for RAID support of M.2 drives (optional; an alternative to VROC)			
BVL1	ThinkSystem Raid 5350-8i for M.2 SATA boot Enablement	SATA	1
BVL3	ThinkSystem Raid 540-8i for M.2 NVMe boot Enablement	NVMe	1

### Configuration notes:

- M.2 is not supported with all storage configurations - see [Storage configurations](#) for details.
- RAID support is implemented using VROC (no adapter needed) or with the use of an additional RAID adapter installed in a slot
- If RAID is enabled using VROC, select these feature codes:
  - VROC SATA support: On Board SATA Software RAID Mode for 7mm (feature BS7U)
  - VROC NVMe support: Intel VROC (VMD NVMe RAID) Standard for 7mm (feature BS7R)
- If RAID is enabled using a RAID adapter, the adapter is installed in PCIe slot 3:



- RAID support for 7mm SATA drives requires a RAID 5350-8i adapter (feature BVL1)
- RAID support for 7mm NVMe drives requires a RAID 540-8i adapter operating in Tri-Mode (feature BVL3)
- ThinkSystem M.2 SATA/x4 NVMe 2-Bay Enablement Kit (4Y37A79663) is not supported with 3.5-inch front drive bays due to physical limitations
- M.2 is not supported in configurations with both EDSFF drives bays and the Integrated Diagnostics Panel (feature B8NH). For M.2 support with EDSFF drives, remove the Integrated Diagnostics Panel from the configuration.
- M.2 and 7mm are mutually exclusive: they are not supported together in the same configuration

The ThinkSystem M.2 SATA/x4 NVMe 2-Bay Enablement Kit has the following features:

- Supports one or two M.2 drives, either SATA or NVMe
- When two drives installed, they must be either both SATA or both NVMe
- Support 42mm, 60mm, 80mm and 110mm drive form factors (2242, 2260, 2280 and 22110)
- On the SR630 V3, RAID support is implemented using VROC or a separate RAID adapter
- Either 6Gbps SATA or PCIe 4.0 x4 interface to the drives depending on the drives installed
- Supports monitoring and reporting of events and temperature through I2C
- Firmware update via Lenovo firmware update tools

### M.2 field upgrades

For field upgrades, the SR630 V3 also requires an additional M.2 cable kit. Ordering information is listed in the following table.

Table 27. M.2 Cable Kits for field upgrades

Part number	Description
4X97A87144	ThinkSystem SR630 V3 M.2 SATA/NVMe x4 Non RAID Cable Kit (Cable kit for use with ThinkSystem M.2 SATA/x4 NVMe 2-Bay Enablement Kit, 4Y37A79663)
RAID adapters for M.2 RAID support	
4Y37A72482	ThinkSystem RAID 5350-8i PCIe 12Gb Adapter (SATA M.2 support)
4Y37A78834	ThinkSystem RAID 540-8i PCIe Gen4 12Gb Adapter (NVMe M.2 support using Tri-Mode)

### SED encryption key management with ISKLM

The server supports self-encrypting drives (SEDs) as listed in the [Internal drive options](#) section. To effectively manage a large deployment of these drives in Lenovo servers, IBM Security Key Lifecycle Manager (SKLM) offers a centralized key management solution. A Lenovo Feature on Demand (FoD) upgrade is used to enable this SKLM support in the management processor of the server.

The following table lists the part numbers and feature codes for the upgrades.

Table 28. FoD upgrades for SKLM support

Part number	Feature code	Description
Security Key Lifecycle Manager - FoD (United States, Canada, Asia Pacific, and Japan)		
00D9998	A5U1	SKLM for System x/ThinkSystem w/SEDs - FoD per Install with 1 year S&S
00D9999	AS6C	SKLM for System x/ThinkSystem w/SEDs - FoD per Install with 3 year S&S
Security Key Lifecycle Manager - FoD (Latin America, Europe, Middle East, and Africa)		
00FP648	A5U1	SKLM for System x/ThinkSystem w/SEDs - FoD per Install with 1 year S&S
00FP649	AS6C	SKLM for System x/ThinkSystem w/SEDs - FoD per Install with 3 year S&S

The IBM Security Key Lifecycle Manager software is available from Lenovo using the ordering information listed in the following table.

Table 29. IBM Security Key Lifecycle Manager licenses

Part number	Description
7S0A007FWW	IBM Security Key Lifecycle Manager Basic Edition Install License + SW Subscription & Support 12 Months
7S0A007HWW	IBM Security Key Lifecycle Manager For Raw Decimal Terabyte Storage Resource Value Unit License + SW Subscription & Support 12 Months
7S0A007KWW	IBM Security Key Lifecycle Manager For Raw Decimal Petabyte Storage Resource Value Unit License + SW Subscription & Support 12 Months
7S0A007MWW	IBM Security Key Lifecycle Manager For Usable Decimal Terabyte Storage Resource Value Unit License + SW Subscription & Support 12 Months
7S0A007PWW	IBM Security Key Lifecycle Manager For Usable Decimal Petabyte Storage Resource Value Unit License + SW Subscription & Support 12 Months

## Controllers for internal storage

The SR630 V3 offers a variety of controller options for internal drives:

- For 2.5-inch, 3.5-inch drives and EDSFF drives:
  - Onboard SATA ports with software RAID support (Intel VROC SATA RAID, formerly known as Intel RSTe)
  - Onboard NVMe ports with software RAID support (Intel VROC NVMe RAID)
  - PCIe Retimer adapter for NVMe drives (PCIe slot-based)
  - RAID adapters and HBAs for SAS/SATA drives (PCIe slot-based)
  - RAID adapters and HBAs for SAS/SATA drives (cabled in a dedicated space)
- For 7mm drive bays in the rear of the server (see the [7mm drives](#) section)
  - SATA controller integrated into the 7mm drive bay enclosure
  - NVMe controller integrated into the 7mm drive bay enclosure (Intel VROC for RAID)
- For M.2 drives internal to the server (see [M.2 drives](#) section)
  - SATA controller integrated on the M.2 adapters
  - NVMe controller integrated on the M.2 adapters (Intel VROC for RAID)

As well as supporting RAID adapters and HBAs that install in a PCIe slot, the SR630 V3 with 2.5-inch front drive bays supports a custom form factor (CFF) adapter that is mounted in the server and cabled to one of the onboard NVMe ports. CFF adapters are not supported with 3.5-inch front drives due to a lack of physical space.

The following table lists the adapters used for the internal storage of the server.

Table 30. Storage controller support for internal drives

Part number	Feature code	Description	Power module (supercap)	Maximum supported	Slots supported
Onboard SATA - 8 drives - Intel VROC SATA RAID (Intel RSTe)					
None	AVV0	On Board SATA Software RAID Mode	No	1	Not applicable
Onboard NVMe - 16 drives - Intel VROC NVMe RAID - see <a href="#">Intel VROC</a> section					
None	BR9B	Intel VROC (VMD NVMe RAID) Standard (supports RAID 0, 1, 10 for all brands of drives)	No	1	Not applicable

Part number	Feature code	Description	Power module (supercap)	Maximum supported	Slots supported
4L47A39164	B96G	Intel VROC (VMD NVMe RAID) Premium (license upgrade - to enable RAID-5 support)	No	1	Not applicable
<b>SAS/SATA RAID - PCIe 3.0 adapters</b>					
4Y37A84028	BRQV	ThinkSystem RAID 5350-8i PCIe 12Gb Internal Adapter	No	1	None (cabled)
4Y37A72482	BJHK	ThinkSystem RAID 5350-8i PCIe 12Gb Adapter	No	1	1
4Y37A72483	BJHL	ThinkSystem RAID 9350-8i 2GB Flash PCIe 12Gb Adapter	Included	1	1
4Y37A72484	BJHM	ThinkSystem RAID 9350-8i 2GB Flash PCIe 12Gb Internal Adapter	Included	1*	None (cabled)
4Y37A72485	BJHN	ThinkSystem RAID 9350-16i 4GB Flash PCIe 12Gb Adapter	Included	1	1
4Y37A72486	BJHP	ThinkSystem RAID 9350-16i 4GB Flash PCIe 12Gb Internal Adapter	Included	1*	None (cabled)
<b>SAS/SATA RAID - PCIe 4.0 adapters</b>					
4Y37A78834	BMFT	ThinkSystem RAID 540-8i PCIe Gen4 12Gb Adapter	No	1	1
4Y37A78835	BNAX	ThinkSystem RAID 540-16i PCIe Gen4 12Gb Adapter	No	1	1
4Y37A09728†	B8NY	ThinkSystem RAID 940-8i 4GB Flash PCIe Gen4 12Gb Adapter	Included	1	1
4Y37A78600†	BM35	ThinkSystem RAID 940-16i 4GB Flash PCIe Gen4 12Gb Adapter	Included	1	1
4Y37A09730†	B8NZ	ThinkSystem RAID 940-16i 8GB Flash PCIe Gen4 12Gb Adapter	Included	1	1
4Y37A09735	B8P0	ThinkSystem RAID 940-16i 8GB Flash PCIe Gen4 12Gb Internal Adapter	Included	1*	None (cabled)
<b>SAS/SATA HBA - PCIe 3.0 adapters</b>					
4Y37A72480	BJHH	ThinkSystem 4350-8i SAS/SATA 12Gb HBA	No	1	1
4Y37A72481	BJHJ	ThinkSystem 4350-16i SAS/SATA 12Gb HBA	No	1	1
<b>SAS/SATA HBA - PCIe 4.0 adapters</b>					
4Y37A78601	BM51	ThinkSystem 440-8i SAS/SATA PCIe Gen4 12Gb HBA	No	1	1
4Y37A78602	BM50	ThinkSystem 440-16i SAS/SATA PCIe Gen4 12Gb HBA	No	1	1
4Y37A09725	B8P1	ThinkSystem 440-16i SAS/SATA PCIe Gen4 12Gb Internal HBA	No	1*	None (cabled)
<b>NVMe</b>					
4C57A65446	B98C	ThinkSystem 4-Port PCIe Gen4 NVMe Retimer Adapter	No	2	1, 2
4Y37A09728†	BGM1	ThinkSystem RAID 940-8i 4GB Flash PCIe Gen4 12Gb Adapter for U.3	Included	1	1

\* Only supported with 2.5-inch front drive bays. Not supported in configurations with 3.5-inch front drive bays.

† Adapter also supported PCIe 4.0 x1 connectivity to NVMe drives with U.3 interface

Configuration notes:

- **Supercap support limits the number of RAID adapters installable** : The table lists whether the adapter includes a power module (supercap) to power the flash memory. The server supports between 1 and 3 supercaps depending on the server configuration as described in the [RAID flash power module \(supercap\) support](#) section. The number of supercaps supported also determines the maximum number of RAID adapters with flash that can be installed in the server.
- **Field upgrades**: If you are adding a RAID adapter with supercap to the server as a field upgrade, you may need a supercap holder as described in the [RAID flash power module \(supercap\) support](#) section.
- **7mm drive support**: The storage adapters listed in the table below do *not* provide connectivity to the 7mm drive bays that are optionally available at the rear of the server. See the [7mm drives](#) section for details.
- **E810 Ethernet and X350 RAID/HBAs**: The use of both an Intel E810 network adapter and an X350 HBA/RAID adapter (9350, 5350 and 4350) is currently not supported in ThinkSystem servers. For details see [Support Tip HT513226](#). Planned support for this combination of adapters is 2Q/2023 (23A).

The RAID 940-8i and RAID 940-16i adapters also support NVMe through a feature named Tri-Mode support (or Trimode support). This feature enables the use of NVMe U.3 drives at the same time as SAS and SATA drives. Cabling of the controller to the backplanes is the same as with SAS/SATA drives, and the NVMe drives are connected via a PCIe x1 link to the controller.

NVMe drives connected using Tri-Mode support provide better performance than SAS or SATA drives: A SATA SSD has a data rate of 6Gbps, a SAS SSD has a data rate of 12Gbps, whereas an NVMe U.3 Gen 4 SSD with a PCIe x1 link will have a data rate of 16Gbps. NVMe drives typically also have lower latency and higher IOPS compared to SAS and SATA drives. Tri-Mode is supported with U.3 NVMe drives in either 2.5-inch and 3.5-inch form factor and requires an AnyBay backplane.

**Tri-Mode requires U.3 drives**: Only NVMe drives with a U.3 interface are supported. U.2 drives are not supported. See the [Internal drive options](#) section for the U.3 drives supported by the server.

The onboard SATA controller has the following features:

- Controller integrated into the Intel PCH
- 6 Gbps SATA host interface
- Supports up to 12 SATA drives
- Supports RAID-0, 1, 5, 10 up to 8 drives (Intel VROC SATA RAID, previously known as RSTe)
- Supports JBOD
- Supports HDDs and SSDs; can be mixed

**SATA RAID support limited to 8 drives**: The SR630 V3 supports 12 SATA drives connected to the onboard SATA controller, however only the first 8 drives can be configured in VROC SATA RAID arrays. The remaining 4 drives can only be configured as JBOD.

The onboard NVMe support has the following features:

- Controller integrated into the Intel processor
- Supports up to 16 NVMe drives direct connected to onboard ports
- Each drive has PCIe 5.0 x4 host interface
- Supports JBOD only - Intel and non-Intel NVMe SSDs
- Supports RAID-0, 1, 10 on Intel and non-Intel NVMe SSDs - Intel VROC Standard
- VROC Premium adds RAID-5 support on Intel and non-Intel NVMe SSDs

## Intel VROC onboard RAID

Intel VROC (Virtual RAID on CPU) is a feature of the Intel processor that enables RAID support.

There are two separate functions of VROC in the SR630 V3:

- Intel VROC SATA RAID, formerly known as Intel RSTe
- Intel VROC NVMe RAID

VROC SATA RAID (RSTe) is available and supported with all SATA drives, both SATA SSDs and SATA HDDs. It offers a 6 Gb/s connection to each drive and on the SR630 V3 implements RAID levels 0, 1, 5, and 10. RAID 1 is limited to 2 drives per array, and RAID 10 is limited to 4 drives per array. Hot-spare functionality is also supported.

VROC NVMe RAID offers RAID support for any NVMe drives directly connected to the ports on the server's system board or via adapters such as NVMe retimers or NVMe switch adapters. On the SR630 V3, it implements RAID levels 0, 1, and 10. RAID 1 is limited to 2 drives per array, and RAID 10 is limited to 4 drives per array. Hot-spare functionality is also supported.

**Performance tip:** For best performance with VROC NVMe RAID, the drives in an array should all be connected to the same processor. Spanning processors is possible however performance will be unpredictable and should be evaluated based on your workload.

By default, VROC NVMe RAID on the SR630 V3 does not support RAID 5 (VROC Standard, feature BR9B). If you wish to enable RAID-5 support, select the VROC Premium license using the ordering information in the following table. VROC Premium is fulfilled as a Feature on Demand (FoD) license and is activated via the XCC management processor user interface.

Table 31. VROC upgrade

Part number	Feature code	Description
4L47A39164	B96G	Intel VROC (VMD NVMe RAID) Premium

VROC Premium is only needed on the SR630 V3 for RAID-5 support with NVMe drives. You do not need the VROC Premium license upgrade under any of the following conditions:

- If you have SATA drives connected to the onboard SATA ports, you do not need VROC Premium
- If you are using RAID 0, 1 or 10 with NVMe drives, you do not need VROC Premium

**Virtualization support:** Virtualization support for Intel VROC is as follows:

- **VROC SATA RAID (RSTe):** VROC SATA RAID is not supported by virtualization hypervisors such as ESXi, KVM, Xen, and Hyper-V. Virtualization is only supported on the onboard SATA ports in AHCI (non-RAID) mode.
- **VROC (VMD) NVMe RAID :** VROC (VMD) NVMe RAID is supported by ESXi, KVM, Xen, and Hyper-V. ESXi support is limited to RAID 1 only; other RAID levels are not supported. Windows and Linux OSes support VROC RAID NVMe, both for host boot functions and for guest OS function, and RAID-0, 1, 5, and 10 are supported.

For specifications about the RAID adapters and HBAs supported by the SR630 V3, see the ThinkSystem RAID Adapter and HBA Comparison, available from:

<https://lenovopress.com/lp1288-lenovo-thinksystem-raid-adapter-and-hba-reference#sr630-v3-support=SR630%2520V3>

For details about these adapters, see the relevant product guide:

- SAS HBAs: <https://lenovopress.com/servers/options/hba>

- RAID adapters: <https://lenovopress.com/servers/options/raid>

## Internal drive options

The following tables list the drive options for internal storage of the server.

2.5-inch hot-swap drives:

- [2.5-inch hot-swap 12 Gb SAS HDDs](#)
- [2.5-inch hot-swap 24 Gb SAS SSDs](#)
- [2.5-inch hot-swap 6 Gb SATA SSDs](#)
- [2.5-inch hot-swap PCIe 4.0 NVMe SSDs](#)

2.5-inch 7mm hot-swap drives:

- [7mm 2.5-inch hot-swap 6 Gb SATA SSDs](#)
- [7mm 2.5-inch hot-swap PCIe 4.0 NVMe SSDs](#)

EDSFF hot-swap drives:

- [E1.S EDSFF hot-swap PCIe 4.0 NVMe SSDs](#)

3.5-inch hot-swap drives:

- [3.5-inch hot-swap 12 Gb SAS HDDs](#)
- [3.5-inch hot-swap 6 Gb SATA HDDs](#)
- [3.5-inch hot-swap 24 Gb SAS SSDs](#)
- [3.5-inch hot-swap 6 Gb SATA SSDs](#)
- [3.5-inch hot-swap PCIe 4.0 NVMe SSDs](#)

M.2 drives:

- [M.2 SATA drives](#)
- [M.2 PCIe 4.0 NVMe drives](#)

**M.2 drive support:** The use of M.2 drives requires an additional adapter as described in the [M.2 drives](#) subsection.

**SED support:** The tables include a column to indicate which drives support SED encryption. The encryption functionality can be disabled if needed. Note: Not all SED-enabled drives have "SED" in the description.

Table 32. 2.5-inch hot-swap 12 Gb SAS HDDs

Part number	Feature code	Description	SED support	Max Qty
<b>2.5-inch hot-swap HDDs - 12 Gb SAS 15K</b>				
7XB7A00021	AULV	ThinkSystem 2.5" 300GB 15K SAS 12Gb Hot Swap 512n HDD	No	12
7XB7A00022	AULW	ThinkSystem 2.5" 600GB 15K SAS 12Gb Hot Swap 512n HDD	No	12
7XB7A00023	AULX	ThinkSystem 2.5" 900GB 15K SAS 12Gb Hot Swap 512e HDD	No	12
<b>2.5-inch hot-swap HDDs - 12 Gb SAS 10K</b>				
7XB7A00025	AULZ	ThinkSystem 2.5" 600GB 10K SAS 12Gb Hot Swap 512n HDD	No	12
7XB7A00027	AUM1	ThinkSystem 2.5" 1.2TB 10K SAS 12Gb Hot Swap 512n HDD	No	12
7XB7A00028	AUM2	ThinkSystem 2.5" 1.8TB 10K SAS 12Gb Hot Swap 512e HDD	No	12
4XB7A83970	BRG7	ThinkSystem 2.5" 2.4TB 10K SAS 12Gb Hot Swap 512e HDD v2	No	12
<b>2.5-inch hot-swap SED HDDs - 12 Gb SAS 10K</b>				
7XB7A00031	AUM5	ThinkSystem 2.5" 600GB 10K SAS 12Gb Hot Swap 512n HDD SED	Support	12
7XB7A00033	B0YX	ThinkSystem 2.5" 1.2TB 10K SAS 12Gb Hot Swap 512n HDD SED	Support	12
4XB7A84038	BRG8	ThinkSystem 2.5" 2.4TB 10K SAS 12Gb Hot Swap 512e HDD FIPS v2	Support	12

Table 33. 2.5-inch hot-swap 24 Gb SAS SSDs

Part number	Feature code	Description	SED support	Max Qty
<b>2.5-inch hot-swap SSDs - 24 Gb SAS - Mixed Use/Mainstream (3-5 DWPD)</b>				
4XB7A80340	BNW8	ThinkSystem 2.5" PM1655 800GB Mixed Use SAS 24Gb HS SSD	Support	12
4XB7A80341	BNW9	ThinkSystem 2.5" PM1655 1.6TB Mixed Use SAS 24Gb HS SSD	Support	12
4XB7A80342	BNW6	ThinkSystem 2.5" PM1655 3.2TB Mixed Use SAS 24Gb HS SSD	Support	12
4XB7A80343	BP3K	ThinkSystem 2.5" PM1655 6.4TB Mixed Use SAS 24Gb HS SSD	Support	12
<b>2.5-inch hot-swap SSDs - 24 Gb SAS - Read Intensive/Entry/Capacity (&lt;3 DWPD)</b>				
4XB7A80318	BNWC	ThinkSystem 2.5" PM1653 960GB Read Intensive SAS 24Gb HS SSD	Support	12
4XB7A80319	BNWE	ThinkSystem 2.5" PM1653 1.92TB Read Intensive SAS 24Gb HS SSD	Support	12
4XB7A80320	BNWF	ThinkSystem 2.5" PM1653 3.84TB Read Intensive SAS 24Gb HS SSD	Support	12
4XB7A80321	BP3E	ThinkSystem 2.5" PM1653 7.68TB Read Intensive SAS 24Gb HS SSD	Support	12
4XB7A80322	BP3J	ThinkSystem 2.5" PM1653 15.36TB Read Intensive SAS 24Gb HS SSD	Support	12
4XB7A80323	BP3D	ThinkSystem 2.5" PM1653 30.72TB Read Intensive SAS 24Gb HS SSD	Support	12

Table 34. 2.5-inch hot-swap 6 Gb SATA SSDs

Part number	Feature code	Description	SED support	Max Qty
<b>2.5-inch hot-swap SSDs - 6 Gb SATA - Mixed Use/Mainstream (3-5 DWPD)</b>				
4XB7A82289	BQ21	ThinkSystem 2.5" 5400 MAX 480GB Mixed Use SATA 6Gb HS SSD	Support	12
4XB7A82290	BQ24	ThinkSystem 2.5" 5400 MAX 960GB Mixed Use SATA 6Gb HS SSD	Support	12
4XB7A82291	BQ22	ThinkSystem 2.5" 5400 MAX 1.92TB Mixed Use SATA 6Gb HS SSD	Support	12
4XB7A82292	BQ23	ThinkSystem 2.5" 5400 MAX 3.84TB Mixed Use SATA 6Gb HS SSD	Support	12
4XB7A17125	BA7Q	ThinkSystem 2.5" S4620 480GB Mixed Use SATA 6Gb HS SSD	No	12
4XB7A17126	BA4T	ThinkSystem 2.5" S4620 960GB Mixed Use SATA 6Gb HS SSD	No	12
4XB7A17127	BA4U	ThinkSystem 2.5" S4620 1.92TB Mixed Use SATA 6Gb HS SSD	No	12
4XB7A17128	BK7L	ThinkSystem 2.5" S4620 3.84TB Mixed Use SATA 6Gb HS SSD	No	12
<b>2.5-inch hot-swap SSDs - 6 Gb SATA - Read Intensive/Entry (&lt;3 DWPD)</b>				
4XB7A82258	BQ1Q	ThinkSystem 2.5" 5400 PRO 240GB Read Intensive SATA 6Gb HS SSD	Support	12
4XB7A82259	BQ1P	ThinkSystem 2.5" 5400 PRO 480GB Read Intensive SATA 6Gb HS SSD	Support	12
4XB7A82260	BQ1R	ThinkSystem 2.5" 5400 PRO 960GB Read Intensive SATA 6Gb HS SSD	Support	12
4XB7A82261	BQ1X	ThinkSystem 2.5" 5400 PRO 1.92TB Read Intensive SATA 6Gb HS SSD	Support	12
4XB7A82262	BQ1S	ThinkSystem 2.5" 5400 PRO 3.84TB Read Intensive SATA 6Gb HS SSD	Support	12
4XB7A82263	BQ1T	ThinkSystem 2.5" 5400 PRO 7.68TB Read Intensive SATA 6Gb HS SSD	Support	12
4XB7A72438	BM8B	ThinkSystem 2.5" PM893 480GB Read Intensive SATA 6Gb HS SSD	No	12
4XB7A72439	BM8A	ThinkSystem 2.5" PM893 960GB Read Intensive SATA 6Gb HS SSD	No	12
4XB7A72440	BM89	ThinkSystem 2.5" PM893 1.92TB Read Intensive SATA 6Gb HS SSD	No	12
4XB7A72441	BM88	ThinkSystem 2.5" PM893 3.84TB Read Intensive SATA 6Gb HS SSD	No	12
4XB7A72442	BM87	ThinkSystem 2.5" PM893 7.68TB Read Intensive SATA 6Gb HS SSD	No	12
4XB7A17072	B99D	ThinkSystem 2.5" S4520 240GB Read Intensive SATA 6Gb HS SSD	No	12
4XB7A17101	BA7G	ThinkSystem 2.5" S4520 480GB Read Intensive SATA 6Gb HS SSD	No	12
4XB7A17102	BA7H	ThinkSystem 2.5" S4520 960GB Read Intensive SATA 6Gb HS SSD	No	12
4XB7A17103	BA7J	ThinkSystem 2.5" S4520 1.92TB Read Intensive SATA 6Gb HS SSD	No	12
4XB7A17104	BK77	ThinkSystem 2.5" S4520 3.84TB Read Intensive SATA 6Gb HS SSD	No	12
4XB7A17105	BK78	ThinkSystem 2.5" S4520 7.68TB Read Intensive SATA 6Gb HS SSD	No	12



Table 35. 2.5-inch hot-swap PCIe 4.0 NVMe SSDs

Part number	Feature code	Description	SED support	Max Qty
<b>2.5-inch SSDs - U.2 PCIe 4.0 NVMe - Write Intensive/Performance (10+ DWPD)</b>				
4XB7A17158	BKKY	ThinkSystem 2.5" U.2 P5800X 400GB Write Intensive NVMe PCIe 4.0 x4 HS SSD	No	12
4XB7A17159	BKKZ	ThinkSystem 2.5" U.2 P5800X 800GB Write Intensive NVMe PCIe 4.0 x4 HS SSD	No	12
4XB7A17160	BMM8	ThinkSystem 2.5" U.2 P5800X 1.6TB Write Intensive NVMe PCIe 4.0 x4 HS SSD	No	12
<b>2.5-inch SSDs - U.2 PCIe 4.0 NVMe - Mixed Use/Mainstream (3-5 DWPD)</b>				
4XB7A17129	BNEG	ThinkSystem 2.5" U.2 P5620 1.6TB Mixed Use NVMe PCIe 4.0 x4 HS SSD	Support	12
4XB7A17130	BNEH	ThinkSystem 2.5" U.2 P5620 3.2TB Mixed Use NVMe PCIe 4.0 x4 HS SSD	Support	12
4XB7A17133	BNEZ	ThinkSystem 2.5" U.2 P5620 6.4TB Mixed Use NVMe PCIe 4.0 x4 HS SSD	Support	12
4XB7A17136	BA4V	ThinkSystem 2.5" U.2 P5620 12.8TB Mixed Use NVMe PCIe 4.0 x4 HS SSD	Support	12
<b>2.5-inch SSDs - U.3 PCIe 4.0 NVMe - Mixed Use/Mainstream (3-5 DWPD)</b>				
4XB7A79639	BNF1	ThinkSystem 2.5" U.3 7450 MAX 800GB Mixed Use NVMe PCIe 4.0 x4 HS SSD	Support	12
4XB7A13967	BNEJ	ThinkSystem 2.5" U.3 7450 MAX 1.6TB Mixed Use NVMe PCIe 4.0 x4 HS SSD	Support	12
4XB7A13970	BNEY	ThinkSystem 2.5" U.3 7450 MAX 3.2TB Mixed Use NVMe PCIe 4.0 x4 HS SSD	Support	12
4XB7A13971	BNEL	ThinkSystem 2.5" U.3 7450 MAX 6.4TB Mixed Use NVMe PCIe 4.0 x4 HS SSD	Support	12
<b>2.5-inch SSDs - U.2 PCIe 4.0 NVMe - Read Intensive/Entry (&lt;3 DWPD)</b>				
4XB7A13941	BMGD	ThinkSystem 2.5" U.2 P5520 1.92TB Read Intensive NVMe PCIe 4.0 x4 HS SSD	Support	12
4XB7A13942	BMGE	ThinkSystem 2.5" U.2 P5520 3.84TB Read Intensive NVMe PCIe 4.0 x4 HS SSD	Support	12
4XB7A13943	BNEF	ThinkSystem 2.5" U.2 P5520 7.68TB Read Intensive NVMe PCIe 4.0 x4 HS SSD	Support	12
4XB7A13631	BNEQ	ThinkSystem 2.5" U.2 P5520 15.36TB Read Intensive NVMe PCIe 4.0 x4 HS SSD	Support	12
<b>2.5-inch SSDs - U.3 PCIe 4.0 NVMe - Read Intensive/Entry (&lt;3 DWPD)</b>				
4XB7A79646	BNF3	ThinkSystem 2.5" U.3 7450 PRO 960GB Read Intensive NVMe PCIe 4.0 x4 HS SSD	Support	12
4XB7A79647	BNF2	ThinkSystem 2.5" U.3 7450 PRO 1.92TB Read Intensive NVMe PCIe 4.0 x4 HS SSD	Support	12
4XB7A79648	BNF5	ThinkSystem 2.5" U.3 7450 PRO 3.84TB Read Intensive NVMe PCIe 4.0 x4 HS SSD	Support	12
4XB7A79649	BNF4	ThinkSystem 2.5" U.3 7450 PRO 7.68TB Read Intensive NVMe PCIe 4.0 x4 HS SSD	Support	12

**Note:** NVMe PCIe SSDs support surprise hot removal and hot insertion, provided the operating system supports PCIe SSD hot-swap.

Table 36. 7mm 2.5-inch hot-swap 6 Gb SATA SSDs

Part number	Feature code	Description	SED support	Max Qty
<b>7mm 2.5-inch hot-swap SSDs - 6 Gb SATA - Read Intensive/Entry (&lt;3 DWPD)</b>				
4XB7A82264	BQ1U	ThinkSystem 7mm 5400 PRO 240GB Read Intensive SATA 6Gb HS SSD	Support	2
4XB7A82265	BQ1V	ThinkSystem 7mm 5400 PRO 480GB Read Intensive SATA 6Gb HS SSD	Support	2
4XB7A82266	BQ1W	ThinkSystem 7mm 5400 PRO 960GB Read Intensive SATA 6Gb HS SSD	Support	2
4XB7A82267	BR13	ThinkSystem 7mm 5400 PRO 1.92TB Read Intensive SATA 6Gb HS SSD	Support	2
4XB7A82268	BR12	ThinkSystem 7mm 5400 PRO 3.84TB Read Intensive SATA 6Gb HS SSD	Support	2
4XB7A82269	BR11	ThinkSystem 7mm 5400 PRO 7.68TB Read Intensive SATA 6Gb HS SSD	Support	2
4XB7A17106	BK79	ThinkSystem 7mm S4520 240GB Read Intensive SATA 6Gb HS SSD	No	2
4XB7A17107	BK7A	ThinkSystem 7mm S4520 480GB Read Intensive SATA 6Gb HS SSD	No	2
4XB7A17108	BK7B	ThinkSystem 7mm S4520 960GB Read Intensive SATA 6Gb HS SSD	No	2

Table 37. 7mm 2.5-inch hot-swap PCIe 4.0 NVMe SSDs

Part number	Feature code	Description	SED support	Max Qty
<b>7mm 2.5-inch hot-swap SSDs - PCIe 4.0 NVMe - Read Intensive/Entry (&lt;3 DWPD)</b>				
4XB7A82853	BPZ4	ThinkSystem 7mm U.3 7450 PRO 960GB Read Intensive NVMe PCIe 4.0 x4 HS SSD	Support	2
4XB7A82855	BPZ5	ThinkSystem 7mm U.3 7450 PRO 1.92TB Read Intensive NVMe PCIe 4.0 x4 HS SSD	Support	2
4XB7A82856	BPZ6	ThinkSystem 7mm U.3 7450 PRO 3.84TB Read Intensive NVMe PCIe 4.0 x4 HS SSD	Support	2

**Note:** NVMe PCIe SSDs support surprise hot removal and hot insertion, provided the operating system supports PCIe SSD hot-swap.

Table 38. E1.S EDSFF hot-swap PCIe 4.0 NVMe SSDs

Part number	Feature code	Description	SED support	Max Qty
<b>E1.S hot-swap SSDs - PCIe 4.0 NVMe - Read Intensive/Entry (&lt;3 DWPD)</b>				
4XB7A13998	BP3L	ThinkSystem E1.S 5.9mm 7450 PRO 3.84TB Read Intensive NVMe PCIe 4.0 x4 HS SSD	Support	16
4XB7A80499	BPKW	ThinkSystem E1.S 5.9mm 7450 PRO 7.68TB Read Intensive NVMe PCIe 4.0 x4 HS SSD	Support	16

**Note:** NVMe PCIe SSDs support surprise hot removal and hot insertion, provided the operating system supports PCIe SSD hot-swap.

Table 39. 3.5-inch hot-swap 12 Gb SAS HDDs

Part number	Feature code	Description	SED support	Max Qty
<b>3.5-inch hot-swap HDDs - 12 Gb NL SAS</b>				
7XB7A00042	AUU5	ThinkSystem 3.5" 2TB 7.2K SAS 12Gb Hot Swap 512n HDD	No	4
7XB7A00043	AUU6	ThinkSystem 3.5" 4TB 7.2K SAS 12Gb Hot Swap 512n HDD	No	4
7XB7A00044	AUU7	ThinkSystem 3.5" 6TB 7.2K SAS 12Gb Hot Swap 512e HDD	No	4
7XB7A00045	B0YR	ThinkSystem 3.5" 8TB 7.2K SAS 12Gb Hot Swap 512e HDD	No	4
7XB7A00046	AUUG	ThinkSystem 3.5" 10TB 7.2K SAS 12Gb Hot Swap 512e HDD	No	4
7XB7A00067	B117	ThinkSystem 3.5" 12TB 7.2K SAS 12Gb Hot Swap 512e HDD	No	4
4XB7A13906	B496	ThinkSystem 3.5" 14TB 7.2K SAS 12Gb Hot Swap 512e HDD	No	4
4XB7A13911	B7EZ	ThinkSystem 3.5" 16TB 7.2K SAS 12Gb Hot Swap 512e HDD	No	4
4XB7A38266	BCFP	ThinkSystem 3.5" 18TB 7.2K SAS 12Gb Hot Swap 512e HDD	No	4
4XB7A80353	BPKU	ThinkSystem 3.5" 20TB 7.2K SAS 12Gb Hot Swap 512e HDD	No	4
<b>3.5-inch hot-swap SED HDDs - 12 Gb NL SAS</b>				
7XB7A00066	B0YQ	ThinkSystem 3.5" 8TB 7.2K SAS 12Gb Hot Swap 512e HDD FIPS	Support	4

Table 40. 3.5-inch hot-swap 6 Gb SATA HDDs

Part number	Feature code	Description	SED support	Max Qty
<b>3.5-inch hot-swap HDDs - 6 Gb NL SATA</b>				
7XB7A00049	AUUF	ThinkSystem 3.5" 1TB 7.2K SATA 6Gb Hot Swap 512n HDD	No	4
7XB7A00050	AUUD	ThinkSystem 3.5" 2TB 7.2K SATA 6Gb Hot Swap 512n HDD	No	4
7XB7A00051	AUU8	ThinkSystem 3.5" 4TB 7.2K SATA 6Gb Hot Swap 512n HDD	No	4
7XB7A00052	AUUA	ThinkSystem 3.5" 6TB 7.2K SATA 6Gb Hot Swap 512e HDD	No	4
7XB7A00053	AUU9	ThinkSystem 3.5" 8TB 7.2K SATA 6Gb Hot Swap 512e HDD	No	4
7XB7A00054	AUUB	ThinkSystem 3.5" 10TB 7.2K SATA 6Gb Hot Swap 512e HDD	No	4
7XB7A00068	B118	ThinkSystem 3.5" 12TB 7.2K SATA 6Gb Hot Swap 512e HDD	No	4
4XB7A13907	B497	ThinkSystem 3.5" 14TB 7.2K SATA 6Gb Hot Swap 512e HDD	No	4
4XB7A13914	B7F0	ThinkSystem 3.5" 16TB 7.2K SATA 6Gb Hot Swap 512e HDD	No	4
4XB7A38130	BCFH	ThinkSystem 3.5" 18TB 7.2K SATA 6Gb Hot Swap 512e HDD	No	4
4XB7A80354	BPKV	ThinkSystem 3.5" 20TB 7.2K SATA 6Gb Hot Swap 512e HDD	No	4

Table 41. 3.5-inch hot-swap 24 Gb SAS SSDs

Part number	Feature code	Description	SED support	Max Qty
<b>3.5-inch hot-swap SSDs - 24 Gb SAS - Mixed Use/Mainstream (3-5 DWPD)</b>				
4XB7A80344	BNW7	ThinkSystem 3.5" PM1655 800GB Mixed Use SAS 24Gb HS SSD	Support	4
4XB7A80345	BNWA	ThinkSystem 3.5" PM1655 1.6TB Mixed Use SAS 24Gb HS SSD	Support	4
4XB7A80346	BNWB	ThinkSystem 3.5" PM1655 3.2TB Mixed Use SAS 24Gb HS SSD	Support	4
4XB7A80347	BP3G	ThinkSystem 3.5" PM1655 6.4TB Mixed Use SAS 24Gb HS SSD	Support	4
<b>3.5-inch hot-swap SSDs - 24 Gb SAS - Read Intensive/Entry/Capacity (&lt;3 DWPD)</b>				
4XB7A80324	BNWD	ThinkSystem 3.5" PM1653 960GB Read Intensive SAS 24Gb HS SSD	Support	4
4XB7A80325	BNWG	ThinkSystem 3.5" PM1653 1.92TB Read Intensive SAS 24Gb HS SSD	Support	4
4XB7A80326	BNWH	ThinkSystem 3.5" PM1653 3.84TB Read Intensive SAS 24Gb HS SSD	Support	4
4XB7A80327	BP3F	ThinkSystem 3.5" PM1653 7.68TB Read Intensive SAS 24Gb HS SSD	Support	4
4XB7A80328	BP3H	ThinkSystem 3.5" PM1653 15.36TB Read Intensive SAS 24Gb HS SSD	Support	4

Table 42. 3.5-inch hot-swap 6 Gb SATA SSDs

Part number	Feature code	Description	SED support	Max Qty
<b>3.5-inch hot-swap SSDs - 6 Gb SATA - Mixed Use/Mainstream (3-5 DWPD)</b>				
4XB7A17137	BA4W	ThinkSystem 3.5" S4620 480GB Mixed Use SATA 6Gb HS SSD	No	4
4XB7A17138	BA4X	ThinkSystem 3.5" S4620 960GB Mixed Use SATA 6Gb HS SSD	No	4
4XB7A17139	BA4Y	ThinkSystem 3.5" S4620 1.92TB Mixed Use SATA 6Gb HS SSD	No	4
4XB7A17140	BK7P	ThinkSystem 3.5" S4620 3.84TB Mixed Use SATA 6Gb HS SSD	No	4
<b>3.5-inch hot-swap SSDs - 6 Gb SATA - Read Intensive/Entry (&lt;3 DWPD)</b>				
4XB7A17118	BA7K	ThinkSystem 3.5" S4520 240GB Read Intensive SATA 6Gb HS SSD	No	4
4XB7A17119	BA7L	ThinkSystem 3.5" S4520 480GB Read Intensive SATA 6Gb HS SSD	No	4
4XB7A17120	BA7M	ThinkSystem 3.5" S4520 960GB Read Intensive SATA 6Gb HS SSD	No	4
4XB7A17121	BA7N	ThinkSystem 3.5" S4520 1.92TB Read Intensive SATA 6Gb HS SSD	No	4
4XB7A17122	BK7F	ThinkSystem 3.5" S4520 3.84TB Read Intensive SATA 6Gb HS SSD	No	4
4XB7A17123	BK7G	ThinkSystem 3.5" S4520 7.68TB Read Intensive SATA 6Gb HS SSD	No	4

Table 43. 3.5-inch hot-swap PCIe 4.0 NVMe SSDs

Part number	Feature code	Description	SED support	Max Qty
<b>3.5-inch SSDs - U.2 PCIe 4.0 NVMe - Write Intensive/Performance (10+ DWPD)</b>				
4XB7A17161	BMM7	ThinkSystem 3.5" U.2 P5800X 400GB Write Intensive NVMe PCIe 4.0 x4 HS SSD	No	4
4XB7A17162	BMM5	ThinkSystem 3.5" U.2 P5800X 800GB Write Intensive NVMe PCIe 4.0 x4 HS SSD	No	4
4XB7A77070	BMM6	ThinkSystem 3.5" U.2 P5800X 1.6TB Write Intensive NVMe PCIe 4.0 x4 HS SSD	No	4
<b>3.5-inch SSDs - U.2 PCIe 4.0 NVMe - Mixed Use/Mainstream (3-5 DWPD)</b>				
4XB7A17141	BNEK	ThinkSystem 3.5" U.2 P5620 1.6TB Mixed Use NVMe PCIe 4.0 x4 HS SSD	Support	4
4XB7A17143	BNEM	ThinkSystem 3.5" U.2 P5620 3.2TB Mixed Use NVMe PCIe 4.0 x4 HS SSD	Support	4
4XB7A17144	BNEN	ThinkSystem 3.5" U.2 P5620 6.4TB Mixed Use NVMe PCIe 4.0 x4 HS SSD	Support	4
4XB7A17148	BNEP	ThinkSystem 3.5" U.2 P5620 12.8TB Mixed Use NVMe PCIe 4.0 x4 HS SSD	Support	4
<b>3.5-inch SSDs - U.2 PCIe 4.0 NVMe - Read Intensive/Entry (&lt;3 DWPD)</b>				
4XB7A13632	BNES	ThinkSystem 3.5" U.2 P5520 1.92TB Read Intensive NVMe PCIe 4.0 x4 HS SSD	Support	4
4XB7A76777	BNET	ThinkSystem 3.5" U.2 P5520 3.84TB Read Intensive NVMe PCIe 4.0 x4 HS SSD	Support	4
4XB7A76778	BNEU	ThinkSystem 3.5" U.2 P5520 7.68TB Read Intensive NVMe PCIe 4.0 x4 HS SSD	Support	4
4XB7A76779	BNF0	ThinkSystem 3.5" U.2 P5520 15.36TB Read Intensive NVMe PCIe 4.0 x4 HS SSD	Support	4

**Note:** NVMe PCIe SSDs support surprise hot removal and hot insertion, provided the operating system supports PCIe SSD hot-swap.

Table 44. M.2 SATA drives

Part number	Feature code	Description	SED support	Max Qty
<b>M.2 SSDs - 6 Gb SATA - Read Intensive/Entry (&lt;3 DWPD)</b>				
4XB7A82286	BQ1Z	ThinkSystem M.2 5400 PRO 240GB Read Intensive SATA 6Gb NHS SSD	Support	2
4XB7A82287	BQ1Y	ThinkSystem M.2 5400 PRO 480GB Read Intensive SATA 6Gb NHS SSD	Support	2
4XB7A82288	BQ20	ThinkSystem M.2 5400 PRO 960GB Read Intensive SATA 6Gb NHS SSD	Support	2
7N47A00130	AUUV	ThinkSystem M.2 128GB SATA 6Gbps Non-Hot Swap SSD	No	2

Table 45. M.2 PCIe 4.0 NVMe drives

Part number	Feature code	Description	SED support	Max Qty
<b>M.2 SSDs - PCIe 4.0 NVMe - Read Intensive/Entry (&lt;3 DWPD)</b>				
4XB7A13999	BKSR	ThinkSystem M.2 7450 PRO 960GB Read Intensive NVMe PCIe 4.0 x4 NHS SSD	Support	2

## USB memory key

For general portable storage needs, the server also supports the USB memory key option that is listed in the following table.

Table 46. USB memory key

Part number	Feature	Description
4X77A77065	BNWN	ThinkSystem USB 32GB USB 3.0 Flash Drive

## Internal backup units

The server does not support any internal backup units, such as tape drives or RDX drives. External backup units are available as described in the [External backup units](#) section.

## Optical drives

The server supports the external USB optical drive listed in the following table.

Table 47. External optical drive

Part number	Feature code	Description
7XA7A05926	AVV8	ThinkSystem External USB DVD RW Optical Disk Drive

The drive is based on the Lenovo Slim DVD Burner DB65 drive and supports the following formats: DVD-RAM, DVD-RW, DVD+RW, DVD+R, DVD-R, DVD-ROM, DVD-R DL, CD-RW, CD-R, CD-ROM.

## I/O expansion

The SR630 V3 supports a total of up to 3 PCIe slots, all with rear access, plus a dedicated OCP 3.0 SFF slot for networking. Slot availability is based on riser selection. The use of slot 3 requires that both processors be installed. The SR630 V3 also supports front-accessible PCIe slots (planned support 2Q/2023).

**Internal (CFF) RAID adapter/HBA:** For configurations with 2.5-inch front drive bays, an internal RAID adapter or HBA (CFF, custom form factor) can be installed in a dedicated space and cabled to a PCIe 4.0 x8 connector, thereby freeing up a slot for other purposes.

The following figure shows the locations of the rear-accessible and front-accessible slots for each configuration selection. The OCP slot is located below the PCIe slots.

**Front PCIe slots:** Support for front PCIe slots (config F) is planned for 2Q/2023.

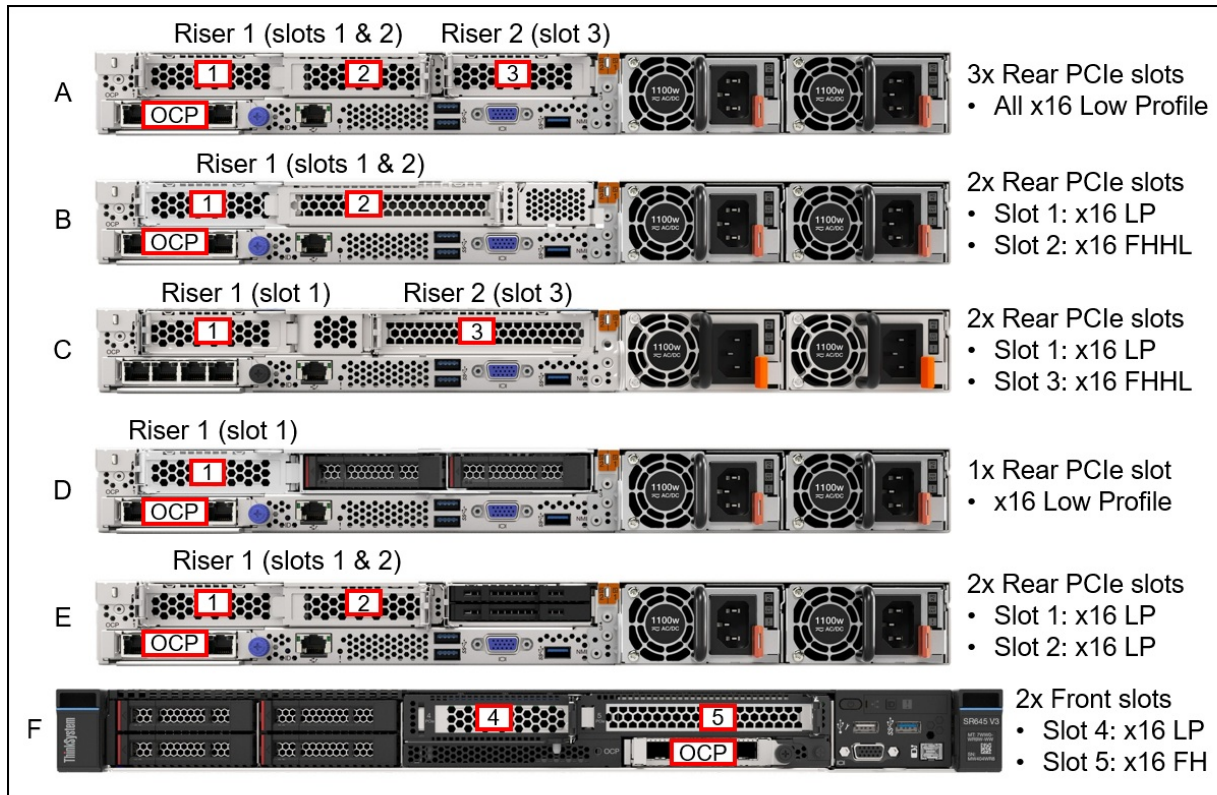

Figure 12. SR630 V3 slot configurations

The rear-accessible slots and riser cards are as follows:

- Riser 1: Slots 1 & 2 (connect to CPU 1)
  - Slot 1: Low Profile, PCIe x16
  - Slot 2: Low Profile or FHHL, PCIe x16 (only in configuration A, B, and E in the above figure)
- Riser 2: Slot 3 (connects to CPU 2)
  - Slot 3: Low Profile or FHHL, PCIe x16 (only in configuration A and C)

The PCIe slots can be configured as PCIe 5.0 (Gen 5) or PCIe 4.0 (Gen 4) depending on your workload requirements.

The front-accessible slots and riser cards are as follows (planned for 2Q/2023):

- Slot 4: Low Profile, PCIe 4.0 x16 (connects to CPU 2)
- Slot 5: FHHL, PCIe 4.0 x16 (connects to CPU 2)

The following table lists the ordering information for the PCIe slots in the SR630 V3. The Cfg column matches the slot configurations shown in the preceding figure. The table is divided up into configurations with Gen5 slots with Gen4, and configurations with only Gen4 slots. Ordering information is as follows:

- For CTO orders, order the feature codes listed for the configuration, both riser and cage feature codes (2, 3, or 4 feature codes, depending on the configuration)
- For field upgrades, order the part numbers listed for the configuration (1 or 2 part numbers, depending on the configuration). The part numbers include both the risers and cages needed for that configuration.

**No slots:** It is also possible to build a configuration without any slots, in which case slot fillers will be derived in the configurator. Slots can be added later as field upgrades using option part numbers as listed in the [Field upgrades table](#).

Table 48. Riser slot ordering information

Cfg	Part number	Features		Description	Slot configuration* (Green = Gen5, Blue = Gen4)			Purpose
		Riser	Cage		Slot 1	Slot 2	Slot 3	
Rear slots - Gen 5					Slot 1	Slot 2	Slot 3	
A	4XH7A83845	BLKB	BLK9	ThinkSystem V3 1U x16/x16 PCIe G5 Riser1 LP+LP	Gen5 x16 LP	Gen5 x16 LP		3x Low Profile slots (3x Gen5)
	4XH7A83843	BLKA	BLK6	ThinkSystem V3 1U x16 PCIe G5 Riser 2			Gen5 x16 LP	
B	4XH7A83844	BLKB	BLK8	ThinkSystem V3 1U x16/x16 PCIe G5 Riser1 LP+FH	Gen5 x16 LP	Gen5 x16 LP	No slot	2x slots, 1xLP+1xFH, both to CPU 1 (2x Gen5)
C	4XH7A85014	BP39	BP3A	ThinkSystem V3 1U x16 PCIe G5 Riser1 with Full Height Slot3	Gen5 x16 LP	No slot		2x slots: 1LP + 1FH, one to each CPU (2x Gen5)
	4XH7A83843	BLKA	BLK6	ThinkSystem V3 1U x16 PCIe G5 Riser 2			Gen5 x16 FH	
D	4XH7A85013	BP39	BLK6	ThinkSystem V3 1U x16 PCIe G5 Riser1 with Rear drive	Gen5 x16 LP	Drive	Drive	Supports 2x 2.5-inch drives (1x Gen5 slots)
E	4XH7A83845	BLKB	BLK9	ThinkSystem V3 1U x16/x16 PCIe G5 Riser1 LP+LP	Gen5 x16 LP	Gen5 x16 LP	Drives	Supports 2x 7mm drives (2x Gen5 slots)
Rear slots - Gen 4					Slot 1	Slot 3	Slot 3	
A	4XH7A83847	BLKF	BLK9	ThinkSystem V3 1U x16/x16 PCIe G4 Riser1 LP+LP	Gen4 x16 LP	Gen4 x16 LP		3x Low Profile slots (2x Gen4)
	4XH7A83849	BLKG	BLK6	ThinkSystem V3 1U x16 PCIe G4 Riser 2 Option Kit			Gen4 x16 LP	
B	4XH7A83846	BLKF	BLK8	ThinkSystem V3 1U x16/x16 PCIe G4 Riser1 LP+FH	Gen4 x16 LP	Gen4 x16 FH	No slot	2x slots, 1xLP+1xFH, both to CPU 1 (2x Gen4)
D	4XH7A83848	BLKE	BLK6	ThinkSystem V3 1U x16 PCIe G4 Riser 1 with Rear drive	Gen4 x16 LP	Drive	Drive	Supports 2x 2.5-inch drives (1x Gen4 slot)
E	4XH7A83847	BLKF	BLK9	ThinkSystem V3 1U x16/x16 PCIe G4 Riser1 LP+LP	Gen4 x16 LP	Gen4 x16 LP	Drives	Supports 2x 7mm drives (2x Gen4 slots)
Front slots - Gen 4 (Planned for 2Q/2023)					Slot 4	Slot 5	OCP	
F	CTO only	BQ2H	BQB3	ThinkSystem SR645 V3/SR635 V3 Front PCIe 1x16 Gen4 LP FL Riser	Gen4 x16 LP			Front PCIe slots (2x Gen4 slots)
	CTO only	BQ2G		ThinkSystem V3 Front PCIe 1x16 Gen4 FHFL FR Riser		Gen4 x16 FH	Gen4 x16 OCP	

Configuration rules:

- For best performance, install PCIe 5.0 adapters in PCIe 5.0 (Gen5) slots
- One only OCP slot can be configured, either front or rear



## Serial port

The SR630 V3 optionally supports a RS-232 serial port by adding a COM port bracket to either slot 2 or slot 3. Ordering information is shown in the following table.

**No front slot support:** The serial port is not supported in the front PCIe slots

Table 49. Serial port

Part number	Feature code	Description
4X97A82921	BMNJ	ThinkSystem COM Port Upgrade Kit

The bracket is shown in the following figure. The option part number includes both Low Profile and Full Height brackets.

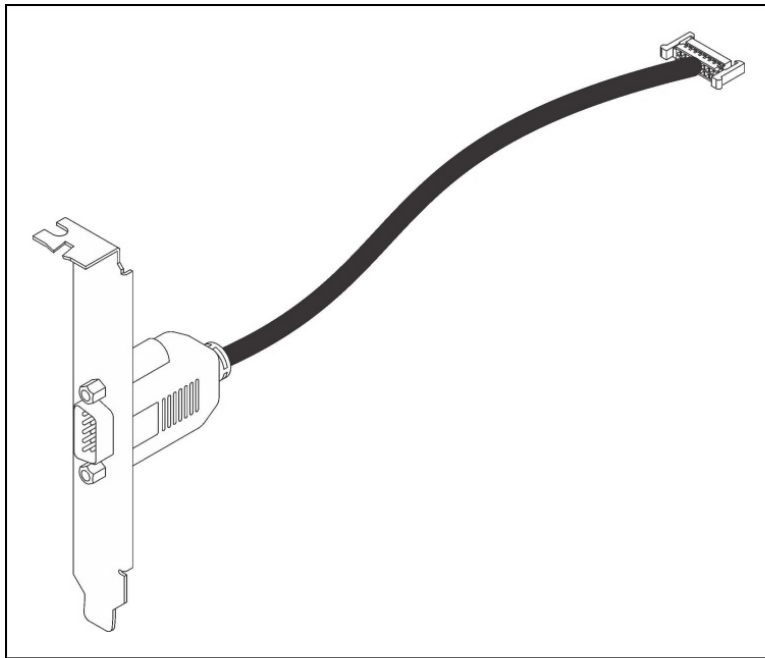

Figure 13. ThinkSystem COM Port Upgrade Kit

## Slot field upgrades

Slot configurations can also be ordered as field upgrades using option part numbers, as listed in the following table.

Table 50. Slot field upgrades

Part number	Description
Riser 1 field upgrades - PCIe Gen5	
4XH7A83844	ThinkSystem V3 1U x16/x16 PCIe G5 Riser1 LP+FH
4XH7A83845	ThinkSystem V3 1U x16/x16 PCIe G5 Riser1 LP+LP
4XH7A85013	ThinkSystem V3 1U x16 PCIe G5 Riser1 with Rear drive
4XH7A85014	ThinkSystem V3 1U x16 PCIe G5 Riser1 with Full Height Slot3
Riser 1 field upgrades - PCIe Gen4	
4XH7A83846	ThinkSystem V3 1U x16/x16 PCIe G4 Riser1 LP+FH
4XH7A83847	ThinkSystem V3 1U x16/x16 PCIe G4 Riser1 LP+LP
4XH7A83848	ThinkSystem V3 1U x16 PCIe G4 Riser 1 with Rear drive
Riser 2 field upgrades	
4XH7A83843	ThinkSystem V3 1U x16 PCIe G5 Riser 2
4XH7A83849	ThinkSystem V3 1U x16 PCIe G4 Riser 2 Option Kit

## Network adapters

The SR630 V3 has a dedicated OCP 3.0 SFF slot with PCIe 5.0 x16 host interface. See [Figure 3](#) for the location of the OCP slot.

The following table lists the supported OCP adapters. One port can optionally be shared with the XCC management processor for Wake-on-LAN and NC-SI support. Only 1 OCP card can be installed in the server.

Table 51. Supported OCP adapters

Part number	Feature code	Description	Maximum supported
<b>Gigabit Ethernet</b>			
4XC7A08235	B5T1	ThinkSystem Broadcom 5719 1GbE RJ45 4-port OCP Ethernet Adapter	1
4XC7A08277	B93E	ThinkSystem Intel I350 1GbE RJ45 4-port OCP Ethernet Adapter	1
<b>10 Gb Ethernet - 10GBASE-T</b>			
4XC7A08236	B5ST	ThinkSystem Broadcom 57416 10GBASE-T 2-port OCP Ethernet Adapter	1
4XC7A08240	B5T4	ThinkSystem Broadcom 57454 10GBASE-T 4-port OCP Ethernet Adapter	1
4XC7A08278	BCD5	ThinkSystem Intel X710-T2L 10GBASE-T 2-port OCP Ethernet Adapter	1
4XC7A80268	BPPY	ThinkSystem Intel X710-T4L 10GBase-T 4-Port OCP Ethernet Adapter	1
<b>25 Gb Ethernet</b>			
4XC7A08237	BN2T	ThinkSystem Broadcom 57414 10/25GbE SFP28 2-Port OCP Ethernet Adapter	1
4XC7A80567	BPPW	ThinkSystem Broadcom 57504 10/25GbE SFP28 4-Port OCP Ethernet Adapter	1
4XC7A08294	BCD4	ThinkSystem Intel E810-DA2 10/25GbE SFP28 2-Port OCP Ethernet Adapter	1
4XC7A80269	BP8L	ThinkSystem Intel E810-DA4 10/25GbE SFP28 4-Port OCP Ethernet Adapter	1
4XC7A62582	BE4T	ThinkSystem Mellanox ConnectX-6 Lx 10/25GbE SFP28 2-Port OCP Ethernet Adapter	1
<b>100 Gb Ethernet</b>			
4XC7A08243	BPPX	ThinkSystem Broadcom 57508 100GbE QSFP56 2-Port OCP Ethernet Adapter	1

The following table lists additional supported network adapters that can be installed in the regular PCIe slots.

Table 52. Supported PCIe Network Adapters

Part number	Feature code	Description	Max qty	Slots	PCIe width
<b>Gigabit Ethernet</b>					
7ZT7A00484	AUZV	ThinkSystem Broadcom 5719 1GbE RJ45 4-Port PCIe Ethernet Adapter	3	1,2,3	PCIe x4
7ZT7A00535	AUZW	ThinkSystem I350-T4 PCIe 1Gb 4-Port RJ45 Ethernet Adapter	3	1,2,3	PCIe x4
<b>10 Gb Ethernet - 10GBASE-T</b>					
7ZT7A00496	AUKP	ThinkSystem Broadcom 57416 10GBASE-T 2-Port PCIe Ethernet Adapter	3	1,2,3	PCIe x8
4XC7A08245	B5SU	ThinkSystem Broadcom 57454 10GBASE-T 4-port PCIe Ethernet Adapter	3	1,2,3	PCIe x8
4XC7A80266	BNWL	ThinkSystem Intel X710-T2L 10GBase-T 2-Port PCIe Ethernet Adapter	3	1,2,3	PCIe x8
4XC7A79699	BMXB	ThinkSystem Intel X710-T4L 10GBase-T 4-Port PCIe Ethernet Adapter	3	1,2,3	PCIe x8
<b>25 Gb Ethernet</b>					
4XC7A08238	BK1H	ThinkSystem Broadcom 57414 10/25GbE SFP28 2-port PCIe Ethernet Adapter	3	1,2,3	PCIe x8
4XC7A80566	BNWM	ThinkSystem Broadcom 57504 10/25GbE SFP28 4-Port PCIe Ethernet Adapter	1	2 or 3	PCIe x8
4XC7A08295	BCD6	ThinkSystem Intel E810-DA2 10/25GbE SFP28 2-Port PCIe Ethernet Adapter	3	1,2,3	PCIe x8
4XC7A80267	BP8M	ThinkSystem Intel E810-DA4 10/25GbE SFP28 4-Port PCIe Ethernet Adapter	1	2 or 3	PCIe x16†
4XC7A62580	BE4U	ThinkSystem Mellanox ConnectX-6 Lx 10/25GbE SFP28 2-Port PCIe Ethernet Adapter	3	1,2,3	PCIe x8
<b>100 Gb Ethernet</b>					
4XC7A08297	BK1J	ThinkSystem Broadcom 57508 100GbE QSFP56 2-port PCIe 4 Ethernet Adapter	3	1,2,3	PCIe x8
4XC7A08248	B8PP	ThinkSystem Mellanox ConnectX-6 Dx 100GbE QSFP56 2-port PCIe Ethernet Adapter	3	1,2,3	PCIe x16
<b>HDR100 InfiniBand (100 GbE)</b>					
4C57A14177	B4R9	ThinkSystem Mellanox ConnectX-6 HDR100/100GbE QSFP56 1-port PCIe VPI Adapter	3	1,2,3	PCIe x16
4C57A14178	B4RA	ThinkSystem Mellanox ConnectX-6 HDR100/100GbE QSFP56 2-port PCIe VPI Adapter	3	1,2,3	PCIe x16
<b>HDR and NDR200 InfiniBand (200 GbE)</b>					
4C57A15326	B4RC	ThinkSystem Mellanox ConnectX-6 HDR/200GbE QSFP56 1-port PCIe 4 VPI Adapter	3	1,2,3	PCIe x16
4XC7A81883	BQBN	ThinkSystem Nvidia ConnectX-7 NDR200/HDR QSFP112 2-Port PCIe Gen5 x16 InfiniBand Adapter	3	1,2,3	PCIe x16
<b>NDR InfiniBand (400 GbE)</b>					
4XC7A80289	BQ1N	ThinkSystem NVIDIA ConnectX-7 NDR400 OSFP 1-Port PCIe Gen5 Adapter	3	1,2,3	PCIe x16

\* Performance fans required. See the [Cooling](#) section

† In the SR630 V3, this adapter requires a full-height bracket and must be installed in a full-height slot (feature BFR3 or option 4XH7A09867). The use of a low-profile bracket and slot is not supported.

For more information, including the transceivers and cables that each adapter supports, see the list of Lenovo Press Product Guides in the Networking adapters category:

<https://lenovopress.com/servers/options/ethernet>

- **E810 Ethernet and X350 RAID/HBAs:** The use of both an Intel E810 network adapter and an X350 HBA/RAID adapter (9350, 5350 and 4350) is currently not supported in ThinkSystem servers. For details see [Support Tip HT513226](#). Planned support for this combination of adapters is 2Q/2023 (23A).

## Fibre Channel host bus adapters

The following table lists the Fibre Channel HBAs supported by the SR630 V3.

Table 53. Fibre Channel HBAs

Part number	Feature code	Description	Maximum supported	Slots supported
<b>16 Gb Fibre Channel HBAs</b>				
01CV840	ATZV	Emulex 16Gb Gen6 FC Dual-port HBA	3	1,2,3
01CV830	ATZU	Emulex 16Gb Gen6 FC Single-port HBA	3	1,2,3
01CV760	ATZC	QLogic 16Gb Enhanced Gen5 FC Dual-port HBA	3	1,2,3
01CV750	ATZB	QLogic 16Gb Enhanced Gen5 FC Single-port HBA	3	1,2,3
<b>32Gb Fibre Channel</b>				
4XC7A76498	BJ3G	ThinkSystem Emulex LPe35000 32Gb 1-port PCIe Fibre Channel Adapter V2	3	1,2,3
4XC7A76525	BJ3H	ThinkSystem Emulex LPe35002 32Gb 2-port PCIe Fibre Channel Adapter V2	3	1,2,3
4XC7A08279	BA1G	ThinkSystem QLogic QLE2770 32Gb 1-Port PCIe Fibre Channel Adapter	3	1,2,3
4XC7A08276	BA1F	ThinkSystem QLogic QLE2772 32Gb 2-Port PCIe Fibre Channel Adapter	3	1,2,3
<b>64Gb Fibre Channel</b>				
4XC7A77485	BLC1	ThinkSystem Emulex LPe36002 64Gb 2-port PCIe Fibre Channel Adapter	3	1,2,3

For more information, see the list of Lenovo Press Product Guides in the Host bus adapters category:

<https://lenovopress.com/servers/options/hba>

## SAS adapters for external storage

The following table lists SAS HBAs and RAID adapters supported by SR630 V3 server for use with external storage.

Table 54. Adapters for external storage

Part number	Feature code	Description	Maximum supported	Slots supported
SAS HBAs - PCIe 4.0				
4Y37A09724	B8P7	ThinkSystem 440-16e SAS/SATA PCIe Gen4 12Gb HBA	3	1,2,3
4Y37A78837	BNWK	ThinkSystem 440-8e SAS/SATA PCIe Gen4 12Gb HBA	3	1,2,3
RAID Adapter - PCIe 4.0				
4Y37A78836	BNWJ	ThinkSystem RAID 940-8e 4GB Flash PCIe Gen4 12Gb Adapter	3	1,2,3

\* See configuration rules below regarding supercap requirements

### Configuration rules

The RAID adapters use a flash power module (supercap), which can be installed in one of the locations as shown in the following figure.

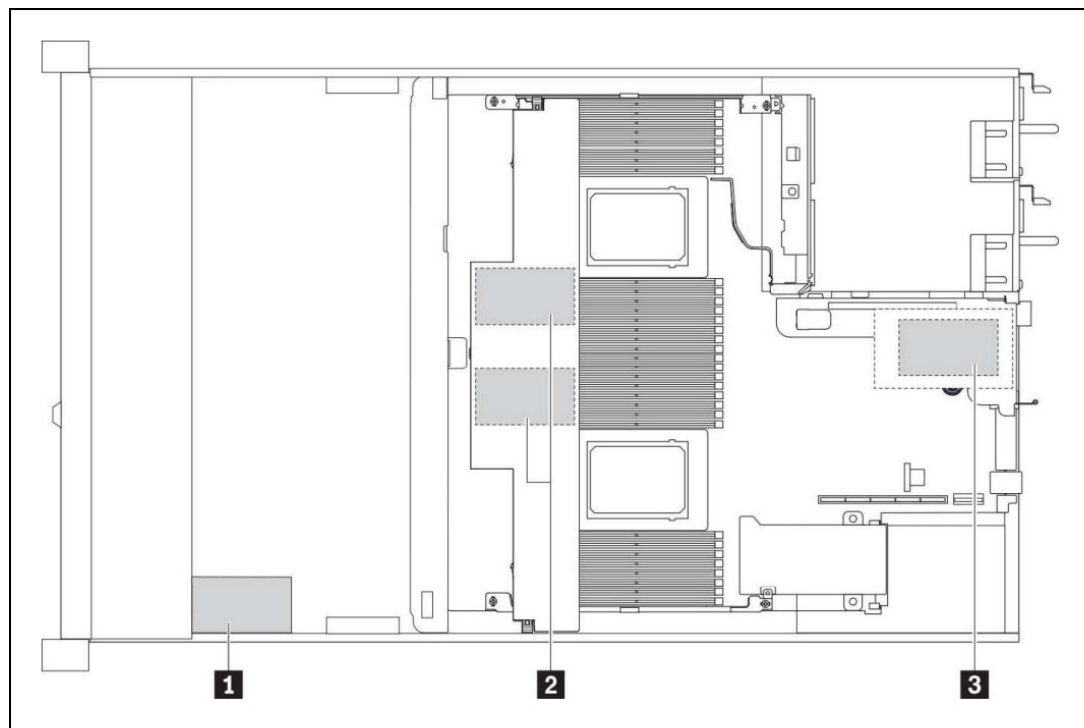

Figure 14. Potential locations of all supercaps in the SR630 V3 (2.5-inch drive configuration and standard heatsinks)

The number of RAID adapters supported is based on how many supercaps can be installed in the server. The number and location of the supercaps is determined based on the front drive configuration used and which processor heatsinks are installed, as listed in the following table.

**Note:** If an internal 9XXX RAID adapter with flash power modules is installed, the maximum number of external RAID adapters supported is reduced by 1.

Table 55. RAID adapters and supercap locations

Front drive configuration	Processor heatsinks	Number of adapters & supercaps	Location of supercaps
2.5-inch	Standard	3	Front of server behind operator panel (1 supercap) Mounted on Air baffle (2 supercaps)
	High Performance	1	Front of server behind operator panel
3.5-inch	Standard	2	Mounted on Air baffle (2 supercaps)
	High Performance	1	Installed in slot 3 attached to Riser 2 (this prevents slot 3 being used for an adapter)

For a comparison of the functions of the supported storage adapters, see the ThinkSystem RAID Adapter and HBA Reference:

<https://lenovopress.lenovo.com/lp1288#sr630-v3-support=SR630%2520V3&internal-or-external-ports=External>

For more information, see the list of Lenovo Press Product Guides in the Host bus adapters and RAID adapters categories:

<https://lenovopress.com/servers/options/hba>

<https://lenovopress.com/servers/options/raid>

## Flash storage adapters

The SR630 V3 currently does not support any Flash storage adapters.

## GPU adapters

The SR630 V3 supports the following graphics processing units (GPUs).

Table 56. Supported GPUs

Part number	Feature code	Description	Maximum supported	Slots supported
4X67A81547	BP05	ThinkSystem NVIDIA A2 16GB PCIe Gen4 Passive GPU	3	1,2,3
CTO only	BQZT	ThinkSystem NVIDIA A2 16GB PCIe Gen4 Passive GPU w/o CEC	3	1,2,3

\* See configuration rules below

For information about these GPUs, see the ThinkSystem GPU Summary, available at:

<https://lenovopress.com/lp0768-thinksystem-thinkagile-gpu-summary>

### Configuration rules

The following configuration requirements must be met when installing GPUs:

- All GPUs installed must be identical
- Processors with TDP greater than 220W TDP (see [Thermal restrictions by processor](#) section):
  - Only 4x 2.5-inch SAS/SATA front drive configuration supported
- For NVIDIA A2 or any other passively cooled GPU (GPU without integrated fan), performance fans are required (see the [Cooling](#) section)

## Cooling

The SR630 V3 server has up to eight 40 mm dual-rotor hot-swap fans. Six fans are needed when one processor is installed and eight fans are required when two processors are installed. The server offers N+1 rotor redundancy. The server also has one additional fan integrated in each of the two power supplies.

Depending on the configuration, the server will need either Standard fans (21K RPM) or Performance fans (24K RPM)

Under the following conditions, Standard fans can be used:

- Processor TDP < 165W
- No GPUs
- None of the following network adapters:
  - Any 100Gb, 200Gb or 400Gb adapter
  - ThinkSystem Broadcom 57454 10GBASE-T 4-port OCP Ethernet Adapter
- No rear drives (2.5-inch or 7mm)
- None of the following front drive bay configurations:
  - EDSFF drive bays
  - 10x 2.5-inch NVMe or AnyBay
  - 8x 2.5-inch NVMe or AnyBay

If any conditions are not met, Performance fans are required.

Ordering information for the fans is listed in the following table.

Table 57. Fan ordering information

Part number	Feature code	Description	Number required
4F17A14488	BH9N	ThinkSystem V2/V3 1U Standard Fan Option Kit	1x CPU: 6 2x CPUs: 8
4F17A14487	BH9M	ThinkSystem V2/V3 1U Performance Fan Option Kit	1x CPU: 6 2x CPUs: 8

## Power supplies

The SR630 V3 supports up to two redundant hot-swap power supplies.

The power supply choices are listed in the following table. Both power supplies used in server must be identical.

**Tip:** When configuring a server in the DCSC configurator, power consumption is calculated precisely by interfacing with Lenovo Capacity Planner. You can therefore select the appropriate power supply for your configuration. However, do consider future upgrades that may require additional power needs.



Table 58. Power supply options

Part number	Feature code	Description	Maximum quantity	110V AC	220V AC	240V DC China only	-48V DC
<b>AC input power -80 PLUS Titanium efficiency</b>							
4P57A82019	BR1X	ThinkSystem 750W 230V Titanium Hot-Swap Gen2 Power Supply v3	2	No	Yes	Yes	No
4P57A72666	BLKH	ThinkSystem 1100W 230V Titanium Hot-Swap Gen2 Power Supply	2	No	Yes	Yes	No
4P57A78359	BPK9	ThinkSystem 1800W 230V Titanium Hot-Swap Gen2 Power Supply	2	No	Yes	Yes	No
<b>AC input power -80 PLUS Platinum efficiency</b>							
4P57A72670	BNFG	ThinkSystem 750W 230V/115V Platinum Hot-Swap Gen2 Power Supply v3	2	Yes	Yes	Yes	No
4P57A72671	BNFH	ThinkSystem 1100W 230V/115V Platinum Hot-Swap Gen2 Power Supply v3	2	Yes	Yes	Yes	No
4P57A26294	BMUF	ThinkSystem 1800W 230V Platinum Hot-Swap Gen2 Power Supply	2	No	Yes	Yes	No
<b>-48V DC input power</b>							
4P57A26296	B8QE	ThinkSystem 1100W -48V DC Hot-Swap Gen2 Power Supply	2	No	No	No	Yes

Supported power supplies are auto-sensing dual-voltage units, supporting both 110V AC (100-127V 50/60 Hz) and 220V AC (200-240V 50/60 Hz) power. For China customers, all power supplies support 240V DC. All supported AC power supplies have a C14 connector.

The supported -48V DC power supply has a Weidmuller TOP 4GS/3 7.6 terminal as shown in the following figure.

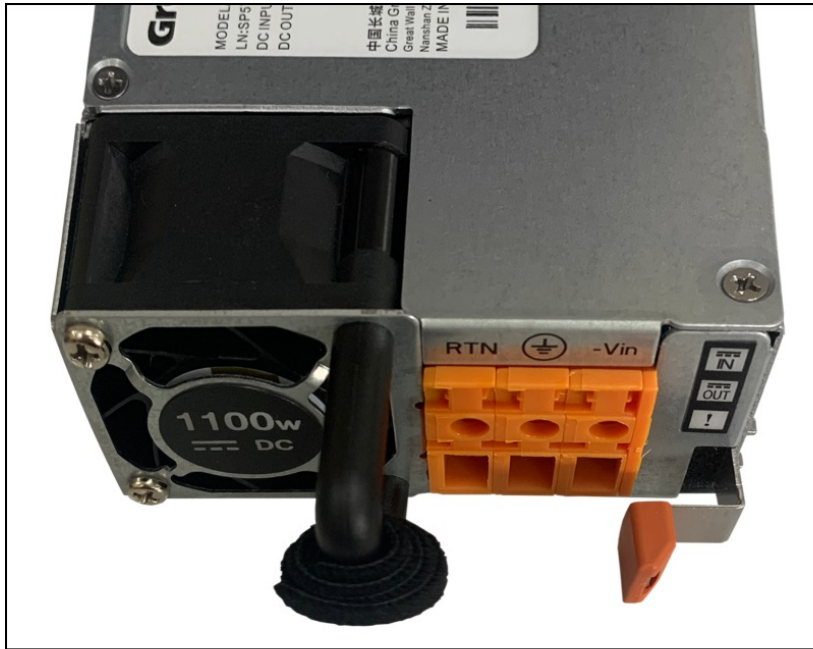

Figure 15. Connector on the ThinkSystem 1100W -48V DC Hot-Swap Gen2 Power Supply

Power supply options do not include a line cord. For server configurations, the inclusion of a power cord is model dependent. Configure-to-order models can be configured without power cords if desired.

The supported hot-swap power supplies have the following LEDs:

- Power input LED:
  - Green: The power supply is connected to the AC power source
  - Off: The power supply is disconnected from the AC power source or a power problem has occurred
- Power output LED:
  - Green: The server is on and the power supply is working normally
  - Blinking green: The power supply is in Standby mode (see below)
  - Off: The server is powered off, or the power supply is not working properly
- Power supply error LED:
  - Off: The power supply is working normally
  - Yellow: The power supply has failed

**Standby mode:** When Standby mode (also known as zero-output mode) is configured in System Setup and the server power load is sufficiently low, one of the installed power supplies enters into the Standby state while the other one delivers entire load. When the power load increases, the standby power supply will switch to Active state to provide sufficient power to the server. Standby mode can be enabled or disabled in System Setup (F1 at boot time) via System Settings > Power > Zero Output and select either Enable or Disable. If you select Disable, then both power supplies will be in the Active state.

## Power cords

Line cords and rack power cables with C13 connectors can be ordered as listed in the following table.

**110V customers:** If you plan to use the 1100W power supply with a 110V power source, select a power cable that is rated above 10A. Power cables that are rated at 10A or below are not supported with 110V power.

Table 59. Power cords

Part number	Feature code	Description
Rack cables - C13 to C14		
SL67B08593	BPHZ	0.5m, 10A/100-250V, C13 to C14 Jumper Cord
00Y3043	A4VP	1.0m, 10A/100-250V, C13 to IEC 320-C14 Rack Power Cable
4L67A08367	B0N5	1.0m, 13A/100-250V, C13 to C14 Jumper Cord
39Y7937	6201	1.5m, 10A/100-250V, C13 to IEC 320-C14 Rack Power Cable
4L67A08368	B0N6	1.5m, 13A/100-250V, C13 to C14 Jumper Cord
4L67A08365	B0N4	2.0m, 10A/100-250V, C13 to IEC 320-C14 Rack Power Cable
4L67A08369	6570	2.0m, 13A/100-250V, C13 to C14 Jumper Cord
4L67A08366	6311	2.8m, 10A/100-250V, C13 to IEC 320-C14 Rack Power Cable
4L67A08370	6400	2.8m, 13A/100-250V, C13 to C14 Jumper Cord
39Y7932	6263	4.3m, 10A/100-250V, C13 to IEC 320-C14 Rack Power Cable
4L67A08371	6583	4.3m, 13A/100-250V, C13 to C14 Rack Power Cable
Rack cables - C13 to C14 (Y-cable)		
00Y3046	A4VQ	1.345m, 2X C13 to C14 Jumper Cord, Rack Power Cable
00Y3047	A4VR	2.054m, 2X C13 to C14 Jumper Cord, Rack Power Cable
Rack cables - C13 to C20		
39Y7938	6204	2.8m, 10A/100-250V, C13 to IEC 320-C20 Rack Power Cable
Rack cables - C13 to C20 (Y-cable)		
47C2491	A3SW	1.2m, 16A/100-250V, 2 Short C13s to Short C20 Rack Power Cable
47C2492	A3SX	2.5m, 16A/100-250V, 2 Long C13s to Short C20 Rack Power Cable
47C2493	A3SY	2.8m, 16A/100-250V, 2 Short C13s to Long C20 Rack Power Cable
47C2494	A3SZ	4.1m, 16A/100-250V, 2 Long C13s to Long C20 Rack Power Cable
Line cords		
39Y7930	6222	2.8m, 10A/250V, C13 to IRAM 2073 (Argentina) Line Cord
81Y2384	6492	4.3m 10A/220V, C13 to IRAM 2073 (Argentina) Line Cord
39Y7924	6211	2.8m, 10A/250V, C13 to AS/NZ 3112 (Australia/NZ) Line Cord
81Y2383	6574	4.3m, 10A/230V, C13 to AS/NZS 3112 (Aus/NZ) Line Cord
69Y1988	6532	2.8m, 10A/250V, C13 to NBR 14136 (Brazil) Line Cord
81Y2387	6404	4.3m, 10A/250V, C13 - 2P+Gnd (Brazil) Line Cord
39Y7928	6210	2.8m, 220-240V, C13 to GB 2099.1 (China) Line Cord
81Y2378	6580	4.3m, 10A/220V, C13 to GB 2099.1 (China) Line Cord
39Y7918	6213	2.8m, 10A/250V, C13 to DK2-5a (Denmark) Line Cord
81Y2382	6575	4.3m, 10A/230V, C13 to DK2-5a (Denmark) Line Cord
39Y7917	6212	2.8m, 10A/230V, C13 to CEE7-VII (Europe) Line Cord
81Y2376	6572	4.3m, 10A/230V, C13 to CEE7-VII (Europe) Line Cord
39Y7927	6269	2.8m, 10A/250V, C13(2P+Gnd) (India) Line Cord
81Y2386	6567	4.3m, 10A/240V, C13 to IS 6538 (India) Line Cord
39Y7920	6218	2.8m, 10A/250V, C13 to SI 32 (Israel) Line Cord
81Y2381	6579	4.3m, 10A/230V, C13 to SI 32 (Israel) Line Cord
39Y7921	6217	2.8m, 220-240V, C13 to CEI 23-16 (Italy/Chile) Line Cord

Part number	Feature code	Description
81Y2380	6493	4.3m, 10A/230V, C13 to CEI 23-16 (Italy/Chile) Line Cord
4L67A08362	6495	4.3m, 12A/200V, C13 to JIS C-8303 (Japan) Line Cord
39Y7922	6214	2.8m, 10A/250V, C13 to SABS 164 (S Africa) Line Cord
81Y2379	6576	4.3m, 10A/230V, C13 to SABS 164 (South Africa) Line Cord
39Y7926	6335	4.3m, 12A/100V, C13 to JIS C-8303 (Japan) Line Cord
39Y7925	6219	2.8m, 220-240V, C13 to KETI (S Korea) Line Cord
81Y2385	6494	4.3m, 12A/220V, C13 to KSC 8305 (S. Korea) Line Cord
39Y7919	6216	2.8m, 10A/250V, C13 to SEV 1011-S24507 (Swiss) Line Cord
81Y2390	6578	4.3m, 10A/230V, C13 to SEV 1011-S24507 (Sws) Line Cord
23R7158	6386	2.8m, 10A/125V, C13 to CNS 10917-3 (Taiwan) Line Cord
81Y2375	6317	2.8m, 10A/240V, C13 to CNS 10917-3 (Taiwan) Line Cord
81Y2374	6402	2.8m, 13A/125V, C13 to CNS 60799 (Taiwan) Line Cord
4L67A08363	AX8B	4.3m, 10A 125V, C13 to CNS 10917 (Taiwan) Line Cord
81Y2389	6531	4.3m, 10A/250V, C13 to 76 CNS 10917-3 (Taiwan) Line Cord
81Y2388	6530	4.3m, 13A/125V, C13 to CNS 10917 (Taiwan) Line Cord
39Y7923	6215	2.8m, 10A/250V, C13 to BS 1363/A (UK) Line Cord
81Y2377	6577	4.3m, 10A/230V, C13 to BS 1363/A (UK) Line Cord
90Y3016	6313	2.8m, 10A/120V, C13 to NEMA 5-15P (US) Line Cord
46M2592	A1RF	2.8m, 10A/250V, C13 to NEMA 6-15P Line Cord
00WH545	6401	2.8m, 13A/120V, C13 to NEMA 5-15P (US) Line Cord
4L67A08359	6370	4.3m, 10A/125V, C13 to NEMA 5-15P (US) Line Cord
4L67A08361	6373	4.3m, 10A/250V, C13 to NEMA 6-15P (US) Line Cord
4L67A08360	AX8A	4.3m, 13A/120V, C13 to NEMA 5-15P (US) Line Cord

### **-48V DC power cord**

For the -48V DC Power Supply, the following power cable is supported.

Table 60. -48V DC power cable

Part number	Feature code	Description
4X97A59831	BE4V	2.5m, -48VDC Interconnecting Cable

## Systems management

The SR630 V3 contains an integrated service processor, XClarity Controller 2 (XCC), which provides advanced control, monitoring, and alerting functions. The XCC2 is based on the AST2600 baseboard management controller (BMC) using a dual-core ARM Cortex A7 32-bit RISC service processor running at 1.2 GHz.

Topics in this section:

- [System I/O Board](#)
- [Local management](#)
- [System status with XClarity Mobile](#)
- [Remote management](#)
- [XCC2 Platinum](#)
- [Lenovo XClarity Provisioning Manager](#)
- [Lenovo XClarity Administrator](#)
- [Lenovo XClarity Integrators](#)
- [Lenovo XClarity Essentials](#)
- [Lenovo XClarity Energy Manager](#)
- [Lenovo Capacity Planner](#)

## System I/O Board

The SR630 V3 implements a separate System I/O Board that connects to the Processor Board. The location of the System I/O Board (also known as the Rear I/O Board in DCSC) is shown in the [Components and connectors](#) section. The System I/O Board contains all the connectors visible at the rear of the server as shown in the following figure.

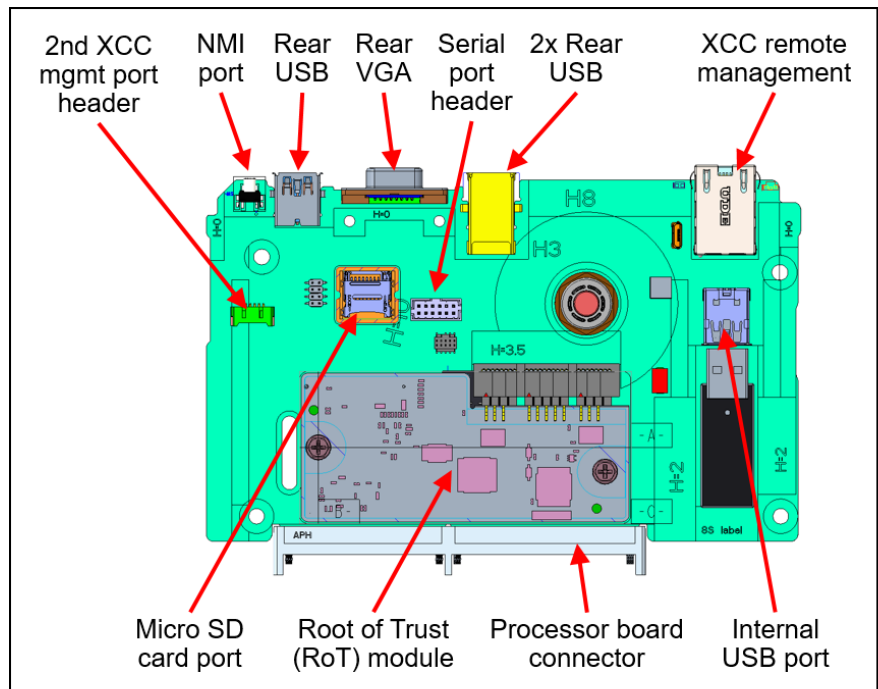

Figure 16. System I/O Board

The board also has the following components:

- Root of Trust (RoT) module - an optional daughter card that implements Platform Firmware Resiliency (PFR) hardware Root of Trust (RoT) which enables the server to be NIST SP800-193 compliant. For more details about PFR, see the [Security](#) section.

- Connector to enable an additional redundant Ethernet connection to the XCC2 controller. The connector is used in conjunction with the ThinkSystem Redundant System Management Port Adapter. For details, see the [Remote management](#) section.
  - Internal USB port - to allow the booting of an operating system from a USB key. The VMware ESXi preloads use this port for example. Preloads are described in the [Operating system support](#) section.
  - MicroSD card port to enable the use of a MicroSD card for additional storage for use with the XCC2 controller. XCC2 can use the storage as a Remote Disc on Card (RDOC) device (up to 4GB of storage). It can also be used to store firmware updates (including N-1 firmware history) for ease of deployment.
- Tip:** Without a MicroSD card installed, the XCC2 controller will have 100MB of available RDOC storage.

Ordering information for the supported USB drive and Micro SD card are listed in the following table.

Table 61. Media for use with the System I/O Board

Part number	Feature code	Description
4X77A77065	BNWN	ThinkSystem USB 32GB USB 3.0 Flash Drive
4X77A77064	BNWP	ThinkSystem MicroSD 32GB Class 10 Flash Memory Card

## Local management

The SR630 V3 offers a front operator panel with key LED status indicators, as shown in the following figure.

**Tip:** The Network LED only shows network activity of the installed OCP network adapter.

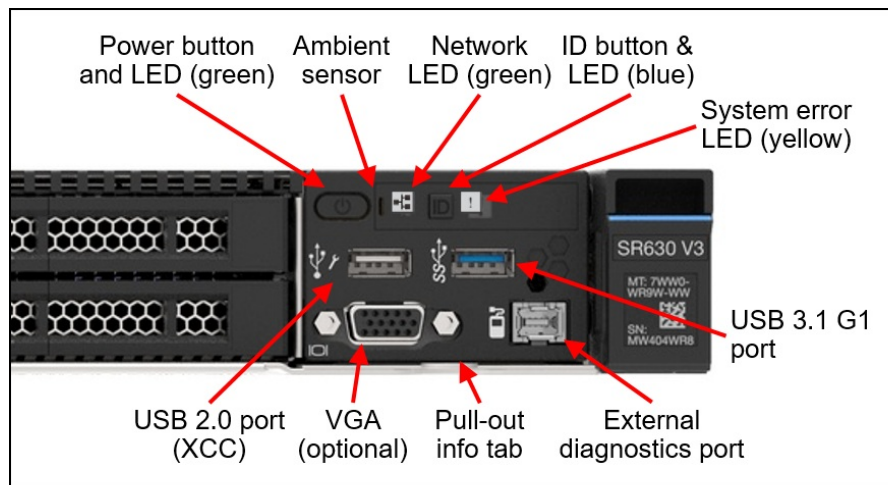

Figure 17. SR630 V3 Front operator panel

## Light path diagnostics

The server offers light path diagnostics. If an environmental condition exceeds a threshold or if a system component fails, the XCC lights LEDs inside the server to help you diagnose the problem and find the failing part. The server has fault LEDs next to the following components:

- Each memory DIMM
- Each drive bay
- Each power supply

## Integrated Diagnostics Panel for 8x 2.5-inch and EDSFF configurations

For configurations with 8x 2.5-inch drive bays or 16x EDSFF drive bays at the front, the server can optionally be configured to have a pull-out Integrated Diagnostics Panel. The following figure shows the configurations with the standard (fixed) operator panel and the optional Integrated Diagnostics Panel.

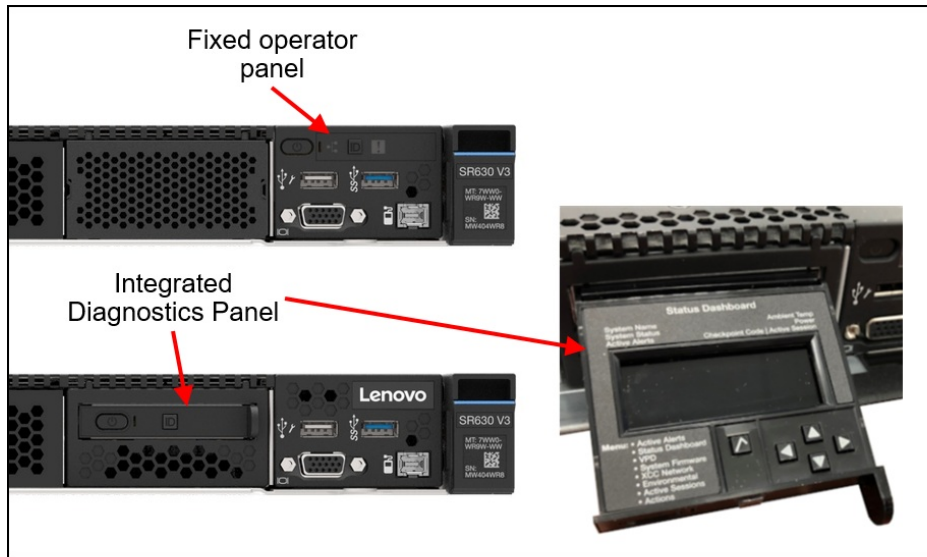

Figure 18. Operator panel choices for the 8x 2.5-inch drive bay configuration

The Integrated Diagnostics Panel allows quick access to system status, firmware, network, and health information. The LCD display on the panel and the function buttons give you access to the following information:

- Active alerts
- Status Dashboard
- System VPD: machine type & mode, serial number, UUID string
- System firmware levels: UEFI and XCC firmware
- XCC network information: hostname, MAC address, IP address, DNS addresses
- Environmental data: Ambient temperature, CPU temperature, AC input voltage, estimated power consumption
- Active XCC sessions
- System reset action

The Integrated Diagnostics Panel can be configured as listed in the following table. It is only available configure-to-order (CTO); not available as a field upgrade.

Table 62. Ordering information for the Integrated Diagnostics Panel

Part number	Feature code	Description
CTO only	B8NH	ThinkSystem 1U Integrated Diagnostics Panel

Configuration rules for the Pull-out operator panel:

- Only supported with configurations with 8x 2.5-inch drive bays
- Not available as a field upgrade. The component is CTO or on pre-configured models only

## Front VGA and External Diagnostics ports

The VGA port at the rear of the server is included in all models, however the VGA port at the front of the server is optional. The ThinkSystem SR635 V3/SR645 V3 Front VGA Cable Option Kit allows you to upgrade your server by adding a VGA video port to the front of the server (if the server does not already come with a front VGA port). When the front VGA is in use, the rear VGA port is automatically disabled.

The SR630 V3 optionally includes a port to connect an External Diagnostics Handset. To include in a server, ensure the appropriate feature code is included, based on the front drive configuration. Field upgrades to add the External Diagnostics port are not available.

Table 63. Front VGA and External Diagnostics ports

Part number	Feature code	Description
Optional VGA port (adds the VGA port to the front of the server)		
4X97A12644	BA2Y	ThinkSystem SR635 V3/SR645 V3 Front VGA Cable Option Kit
Optional port for the External Diagnostic Handset (adds the port to the front of the server)		
CTO only	BLKD	ThinkSystem 1U V3 10x2.5" Media Bay w/ Ext. Diagnostics Port
CTO only	B8NN	ThinkSystem 1U V3 8x2.5" Media Bay w/ External Diagnostics Port
CTO only	BR03	ThinkSystem 1U 4x3.5" Media Bay w/ External Diagnostics Port

### External Diagnostics Handset

The SR630 V3 optionally includes a port to connect an External Diagnostics Handset as described in the previous section. The External Diagnostics Handset has the same functions as the Integrated Diagnostics Panel but has the advantages of not consuming space on the front of the server plus it can be shared among many servers in your data center. The handset has a magnet on the back of it to allow you to easily mount it on a convenient place on any rack cabinet.

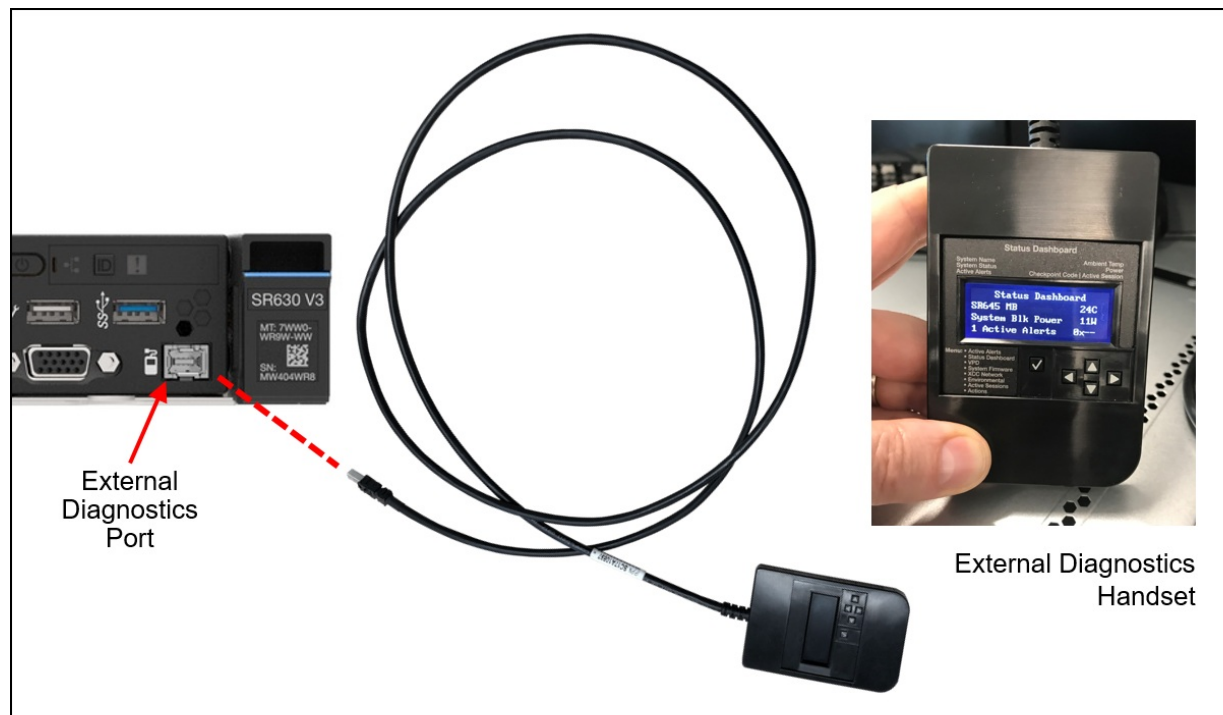

Figure 19. SR630 V3 External Diagnostics Handset

Ordering information for the External Diagnostics Handset with is listed in the following table.



Table 64. External Diagnostics Handset ordering information

Part number	Feature code	Description
4TA7A64874	BEUX	ThinkSystem External Diagnostics Handset

### Information pull-out tab

The front of the server also houses an information pull-out tab (also known as the network access tag). See [Figure 2](#) for the location. A label on the tab shows the network information (MAC address and other data) to remotely access the service processor.

### System status with XClarity Mobile

The XClarity Mobile app includes a tethering function where you can connect your Android or iOS device to the server via USB to see the status of the server.

The steps to connect the mobile device are as follows:

1. Enable USB Management on the server, by holding down the ID button for 3 seconds (or pressing the dedicated USB management button if one is present)
2. Connect the mobile device via a USB cable to the server's USB port with the management symbol 
3. In iOS or Android settings, enable Personal Hotspot or USB Tethering
4. Launch the Lenovo XClarity Mobile app

Once connected you can see the following information:

- Server status including error logs (read only, no login required)
- Server management functions (XClarity login credentials required)

### Remote management

The server offers a dedicated RJ45 Ethernet port at the rear of the server for remote management via the XClarity Controller 2 management processor. The port supports 10/100/1000 Mbps speeds.

Remote server management is provided through industry-standard interfaces:

- Intelligent Platform Management Interface (IPMI) Version 2.0
- Simple Network Management Protocol (SNMP) Version 3 (no SET commands; no SNMP v1)
- Common Information Model (CIM-XML)
- Representational State Transfer (REST) support
- Redfish support (DMTF compliant)
- Web browser - HTML 5-based browser interface (Java and ActiveX not required) using a responsive design (content optimized for device being used - laptop, tablet, phone) with NLS support

The SR630 V3 also supports the use of an OCP adapter that provides an additional redundant Ethernet connection to the XCC2 controller. Ordering information is listed in the following table.

Table 65. Redundant System Management Port Adapter

Part number	Feature code	Description	Maximum quantity
4XC7A85319	BTMQ	ThinkSystem V3 Management NIC Adapter Kit	1

The use of this adapter allows concurrent remote access using both the connection on the adapter and the onboard RJ45 remote management port provided by the server. The adapter and onboard port have separate IP addresses.

Configuration rules:

- The Redundant System Management Port Adapter is installed in the OCP adapter slot at the rear of the server and is mutually exclusive with any OCP network adapter.
- It is not supported installed in the front OCP slot (if the front OCP slot is configured)
- If the Redundant System Management Port Adapter is installed in the rear slot, then the front OCP slot (if configured) cannot be used.

The following figure shows the server with the Redundant System Management Port Adapter installed in the OCP slot.

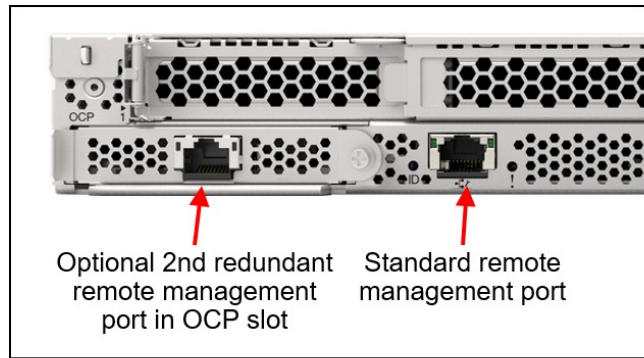

Figure 20. SR630 V3 with the Redundant System Management Port Adapter installed

IPMI via the Ethernet port (IPMI over LAN) is supported, however it is disabled by default. For CTO orders you can specify whether you want to the feature enabled or disabled in the factory, using the feature codes listed in the following table.

Table 66. IPMI-over-LAN settings

Feature code	Description
B7XZ	Disable IPMI-over-LAN (default)
B7Y0	Enable IPMI-over-LAN

## XCC2 Platinum

The XCC2 service processor in the SR630 V3 supports an upgrade to a Platinum level of features. Compared to the XCC functions of ThinkSystem V2 and earlier systems, Platinum adds the same features as Enterprise and Advanced levels in ThinkSystem V2, plus additional features.

XCC2 Platinum adds the following Enterprise and Advanced functions:

- Remotely viewing video with graphics resolutions up to 1600x1200 at 75 Hz with up to 23 bits per pixel, regardless of the system state
- Remotely accessing the server using the keyboard and mouse from a remote client
- International keyboard mapping support
- Syslog alerting
- Redirecting serial console via SSH
- Component replacement log (Maintenance History log)
- Access restriction (IP address blocking)
- Lenovo SED security key management
- Displaying graphics for real-time and historical power usage data and temperature

- Boot video capture and crash video capture
- Virtual console collaboration - Ability for up to 6 remote users to be log into the remote session simultaneously
- Remote console Java client
- Mapping the ISO and image files located on the local client as virtual drives for use by the server
- Mounting the remote ISO and image files via HTTPS, SFTP, CIFS, and NFS
- Power capping
- System utilization data and graphic view
- Single sign on with Lenovo XClarity Administrator
- Update firmware from a repository
- License for XClarity Energy Manager

XCC2 Platinum also adds the following features that are new to XCC2:

- System Guard - Monitor hardware inventory for unexpected component changes, and simply log the event or prevent booting
- Enterprise Strict Security mode - Enforces FIPS 140-3 level security and enhanced NIST 800-193 support
- Neighbor Group - Enables administrators to manage and synchronize configurations and firmware level across multiple servers
- Mini-Log - New service tool that provides XCC first-failure logs in HTML and JSON format

Ordering information is listed in the following table. XCC2 Platinum is a software license upgrade - no additional hardware is required.

Table 67. XCC2 Platinum license upgrade

Part number	Feature code	Description
7S0X000DWW	S91X	Lenovo XClarity XCC2 Platinum Upgrade

## Lenovo XClarity Provisioning Manager

Lenovo XClarity Provisioning Manager (LXPM) is a UEFI-based application embedded in ThinkSystem servers and accessible via the F1 key during system boot.

LXPM provides the following functions:

- Graphical UEFI Setup
- System inventory information and VPD update
- System firmware updates (UEFI and XCC)
- RAID setup wizard
- OS installation wizard (including unattended OS installation)
- Diagnostics functions

## Lenovo XClarity Administrator

Lenovo XClarity Administrator is a centralized resource management solution designed to reduce complexity, speed response, and enhance the availability of Lenovo systems and solutions. It provides agent-free hardware management for ThinkSystem servers, in addition to ThinkServer, System x, and Flex System servers. The administration dashboard is based on HTML 5 and allows fast location of resources so tasks can be run quickly.

Because Lenovo XClarity Administrator does not require any agent software to be installed on the managed endpoints, there are no CPU cycles spent on agent execution, and no memory is used, which means that up to 1GB of RAM and 1 - 2% CPU usage is saved, compared to a typical managed system where an agent is required.

Lenovo XClarity Administrator is an optional software component for the SR630 V3. The software can be downloaded and used at no charge to discover and monitor the SR630 V3 and to manage firmware upgrades.

If software support is required for Lenovo XClarity Administrator, or premium features such as configuration management and operating system deployment are required, Lenovo XClarity Pro software subscription should be ordered. Lenovo XClarity Pro is licensed on a per managed system basis, that is, each managed Lenovo system requires a license.

The following table lists the geo-specific Lenovo XClarity software license options.

Table 68. Lenovo XClarity software options

Part number (NA, AP, Japan markets)	Part number (EMEA, LA markets)	Description
00MT201	00MT207	Lenovo XClarity Pro, per Managed Endpoint w/1 Yr SW S&S
00MT202	00MT208	Lenovo XClarity Pro, per Managed Endpoint w/3 Yr SW S&S
00MT203	00MT209	Lenovo XClarity Pro, per Managed Endpoint w/5 Yr SW S&S

Lenovo XClarity Administrator offers the following standard features that are available at no charge:

- Auto-discovery and monitoring of Lenovo systems
- Firmware updates and compliance enforcement
- External alerts and notifications via SNMP traps, syslog remote logging, and e-mail
- Secure connections to managed endpoints
- NIST 800-131A or FIPS 140-2 compliant cryptographic standards between the management solution and managed endpoints
- Integration into existing higher-level management systems such as cloud automation and orchestration tools through REST APIs, providing extensive external visibility and control over hardware resources
- An intuitive, easy-to-use GUI
- Scripting with Windows PowerShell, providing command-line visibility and control over hardware resources

Lenovo XClarity Administrator offers the following premium features that require an optional Pro license:

- Pattern-based configuration management that allows to define configurations once and apply repeatedly without errors when deploying new servers or redeploying existing servers without disrupting the fabric
- Bare-metal deployment of operating systems and hypervisors to streamline infrastructure provisioning

For more information, refer to the Lenovo XClarity Administrator Product Guide:

<http://lenovopress.com/tips1200>

### Lenovo XClarity Integrators

Lenovo also offers software plug-in modules, Lenovo XClarity Integrators, to manage physical infrastructure from leading external virtualization management software tools including those from Microsoft and VMware.

These integrators are offered at no charge, however if software support is required, a Lenovo XClarity Pro software subscription license should be ordered.

Lenovo XClarity Integrators offer the following additional features:

- Ability to discover, manage, and monitor Lenovo server hardware from VMware vCenter or Microsoft System Center
- Deployment of firmware updates and configuration patterns to Lenovo x86 rack servers and Flex System from the virtualization management tool
- Non-disruptive server maintenance in clustered environments that reduces workload downtime by dynamically migrating workloads from affected hosts during rolling server updates or reboots
- Greater service level uptime and assurance in clustered environments during unplanned hardware events by dynamically triggering workload migration from impacted hosts when impending hardware failures are predicted

For more information about all the available Lenovo XClarity Integrators, see the Lenovo XClarity Administrator Product Guide: <https://lenovopress.com/tips1200-lenovo-xclarity-administrator>

## Lenovo XClarity Essentials

Lenovo offers the following XClarity Essentials software tools that can help you set up, use, and maintain the server at no additional cost:

- **Lenovo Essentials OneCLI**  
OneCLI is a collection of server management tools that uses a command line interface program to manage firmware, hardware, and operating systems. It provides functions to collect full system health information (including health status), configure system settings, and update system firmware and drivers.
- **Lenovo Essentials UpdateXpress**  
The UpdateXpress tool is a standalone GUI application for firmware and device driver updates that enables you to maintain your server firmware and device drivers up-to-date and help you avoid unnecessary server outages. The tool acquires and deploys individual updates and UpdateXpress System Packs (UXSPs) which are integration-tested bundles.
- **Lenovo Essentials Bootable Media Creator**  
The Bootable Media Creator (BOMC) tool is used to create bootable media for offline firmware update.

For more information and downloads, visit the Lenovo XClarity Essentials web page: <http://support.lenovo.com/us/en/documents/LNVO-center>

## Lenovo XClarity Energy Manager

Lenovo XClarity Energy Manager (LXEM) is a power and temperature management solution for data centers. It is an agent-free, web-based console that enables you to monitor and manage power consumption and temperature in your data center through the management console. It enables server density and data center capacity to be increased through the use of power capping.

LXEM is a licensed product. A single-node LXEM license is included with the XClarity Controller Platinum upgrade as described in the [Remote Management](#) section. If your server does not have the XCC Platinum upgrade, Energy Manager licenses can be ordered as shown in the following table.

Table 69. Lenovo XClarity Energy Manager

Part number	Description
4L40E51621	Lenovo XClarity Energy Manager Node License (1 license needed per server)

For more information about XClarity Energy Manager, see the following resources:

- Lenovo Support page:  
<https://datacentersupport.lenovo.com/us/en/solutions/Invo-lxem>
- Lenovo Information Center:  
[https://sysmgmt.lenovofiles.com/help/topic/LXEM/lxem\\_overview.html?cp=4](https://sysmgmt.lenovofiles.com/help/topic/LXEM/lxem_overview.html?cp=4)

## Lenovo Capacity Planner

Lenovo Capacity Planner is a power consumption evaluation tool that enhances data center planning by enabling IT administrators and pre-sales professionals to understand various power characteristics of racks, servers, and other devices. Capacity Planner can dynamically calculate the power consumption, current, British Thermal Unit (BTU), and volt-ampere (VA) rating at the rack level, improving the planning efficiency for large scale deployments.

For more information, refer to the Capacity Planner web page:  
<http://datacentersupport.lenovo.com/us/en/solutions/Invo-lcp>

## Security

Topics in this section:

- [Security features](#)
- [Platform Firmware Resiliency - Lenovo ThinkShield](#)
- [Intel Transparent Supply Chain](#)
- [Security standards](#)

### Security features

The SR630 V3 server offers the following electronic security features:

- Secure Boot function of the Intel Xeon processor
- Support for Platform Firmware Resiliency (PFR) hardware Root of Trust (RoT) - see the [Platform Firmware Resiliency](#) section
- Firmware signature processes compliant with FIPS and NIST requirements
- Administrator and power-on password
- Integrated Trusted Platform Module (TPM) supporting TPM 2.0
- Self-encrypting drives (SEDs) with support for enterprise key managers - see the [SED encryption key management](#) section

The server is NIST SP 800-147B compliant.

The SR630 V3 server also offers the following optional physical security features:

- Optional chassis intrusion switch
- Optional lockable front security bezel

The optional lockable front security bezel is shown in the following figure and includes a key that enables you to secure the bezel over the drives and system controls thereby reducing the chance of unauthorized or accidental access to the server.

**Front PCIe slots:** The use of the security bezel is not supported when the server has front PCIe slots.



Figure 21. Lockable front security bezel

The dimensions of the security bezel are:

- Width: 437 mm (17.2 in.)
- Height: 43 mm (1.3 in.)
- Width: 23 mm (0.9 in.)

The following table lists the physical security options for the SR630 V3.

Table 70. Physical security features

Part number	Feature code	Description
4X97A59835	BA2X	ThinkSystem 1U Intrusion Cable
4XH7A09890	B8NL	ThinkSystem V2/V3 1U Security Bezel v2

### Platform Firmware Resiliency - Lenovo ThinkShield

Lenovo's ThinkShield Security is a transparent and comprehensive approach to security that extends to all dimensions of our data center products: from development, to supply chain, and through the entire product lifecycle.

The ThinkSystem SR630 V3 includes Platform Firmware Resiliency (PFR) hardware Root of Trust (RoT) which enables the system to be NIST SP800-193 compliant. This offering further enhances key platform subsystem protections against unauthorized firmware updates and corruption, to restore firmware to an integral state, and to closely monitor firmware for possible compromise from cyber attacks.

PFR operates upon the following server components:

- UEFI image – the low-level server firmware that connects the operating system to the server hardware
- XCC image – the management “engine” software that controls and reports on the server status separate from the server operating system
- FPGA image – the code that runs the server's lowest level hardware controller on the motherboard

The Lenovo Platform Root of Trust Hardware performs the following three main functions:

- Detection – Measures the firmware and updates for authenticity
- Recovery – Recovers a corrupted image to a known-safe image
- Protection – Monitors the system to ensure the known-good firmware is not maliciously written

These enhanced protection capabilities are implemented using a dedicated, discrete security processor whose implementation has been rigorously validated by leading third-party security firms. Security evaluation results and design details are available for customer review – providing unprecedented transparency and assurance.

The SR630 V3 includes support for Secure Boot, a UEFI firmware security feature developed by the UEFI Consortium that ensures only immutable and signed software are loaded during the boot time. The use of Secure Boot helps prevent malicious code from being loaded and helps prevent attacks, such as the installation of rootkits. Lenovo offers the capability to enable secure boot in the factory, to ensure end-to-end protection. Alternatively, Secure Boot can be left disabled in the factory, allowing the customer to enable it themselves at a later point, if desired.

The following table lists the feature code to enable secure boot in the factory, or to leave it disabled.

Table 71. Secure Boot options

Part number	Feature code	Description	Purpose
CTO only	BPKQ	TPM 2.0 with security boot	Configure the system in the factory with Secure Boot enabled.
CTO only	BPKR	TPM 2.0	Configure the system without Secure Boot enabled. Customers can enable Secure Boot later if desired.

**Tip:** If Secure Boot is not enabled in the factory, it can be enabled later by the customer. However once Secure Boot is enabled, it cannot be disabled.

### Intel Transparent Supply Chain

Add a layer of protection in your data center and have peace of mind that the server hardware you bring into it is safe authentic and with documented, testable, and provable origin.

Lenovo has one of the world’s best supply chains, as ranked by Gartner Group, backed by extensive and mature supply chain security programs that exceed industry norms and US Government standards. Now we are the first Tier 1 manufacturer to offer Intel® Transparent Supply Chain in partnership with Intel, offering you an unprecedented degree of supply chain transparency and assurance.

To enable Intel Transparent Supply Chain for the Intel-based servers in your order, add the following feature code in the [DCSC configurator](#), under the Security tab.

Table 72. Intel Transparent Supply Chain ordering information

Feature code	Description
BB0P	Intel Transparent Supply Chain

For more information on this offering, see the paper *Introduction to Intel Transparent Supply Chain on Lenovo ThinkSystem Servers*, available from <https://lenovopress.com/lp1434-introduction-to-intel-transparent-supply-chain-on-thinksystem-servers>.

### Security standards

The SR630 V3 supports the following security standards and capabilities:

- **Industry Standard Security Capabilities**
  - Intel CPU Enablement
    - AES-NI (Advanced Encryption Standard New Instructions)
    - CBnT (Converged Boot Guard and Trusted Execution Technology)
    - CET (Control flow Enforcement Technology)
    - Hardware-based side channel attack resilience enhancements
    - MKTME/TME (Multi-Key Total Memory Encryption)
    - SGX (Software Guard eXtensions)
    - SGX-TEM (Trusted Environment Mode)
    - TDX (Trust Domain Extensions)
    - TXT (Trusted eXecution Technology)
    - VT (Virtualization Technology)
    - XD (eXecute Disable)
  - Microsoft Windows Security Enablement



- Credential Guard
    - Device Guard
    - Host Guardian Service
  - TCG (Trusted Computing Group) TPM (Trusted Platform Module) 2.0
  - UEFI (Unified Extensible Firmware Interface) Forum Secure Boot
- **Hardware Root of Trust and Security**
  - Independent security subsystem providing platform-wide NIST SP800-193 compliant Platform Firmware Resilience (PFR)
  - Management domain RoT supplemented by the Secure Boot features of XCC
- **Platform Security**

For more information on platform security, see the paper “How to Harden the Security of your ThinkSystem Server and Management Applications” available from <https://lenovopress.com/lp1260-how-to-harden-the-security-of-your-thinksystem-server>.

  - Boot and run-time firmware integrity monitoring with rollback to known-good firmware (e.g., “self-healing”)
  - Non-volatile storage bus security monitoring and filtering
  - Resilient firmware implementation, such as to detect and defeat unauthorized flash writes or SMM (System Management Mode) memory incursions
  - Patented IPMI KCS channel privileged access authorization (USPTO Patent# 11,256,810)
  - Host and management domain authorization, including integration with CyberArk for enterprise password management
  - KMIP (Key Management Interoperability Protocol) compliant, including support for IBM SKLM and Thales KeySecure
  - Reduced “out of box” attack surface
  - Configurable network services
  - FIPS 140-3 (in process) validated cryptography for XCC
  - CNSA Suite 1.0 Quantum-resistant cryptography for XCC
  - Lenovo System Guard
- **Standards Compliance and/or Support**
  - NIST SP800-131A rev 2 “Transitioning the Use of Cryptographic Algorithms and Key Lengths”
  - NIST SP800-147B “BIOS Protection Guidelines for Servers”
  - NIST SP800-193 “Platform Firmware Resiliency Guidelines”
  - ISO/IEC 11889 “Trusted Platform Module Library”
  - Common Criteria TCG Protection Profile for “PC Client Specific TPM 2.0”
  - European Union Commission Regulation 2019/424 (“ErP Lot 9”) “Ecodesign Requirements for Servers and Data Storage Products” Secure Data Deletion
  - Optional FIPS 140-2 validated Self-Encrypting Disks (SEDs) with external KMIP-based key management
- **Product and Supply Chain Security**
  - Suppliers validated through Lenovo’s Trusted Supplier Program
  - Developed in accordance with Lenovo’s Secure Development Lifecycle (LSDL)
  - Continuous firmware security validation through automated testing, including static code analysis, dynamic network and web vulnerability testing, software composition analysis, and subsystem-specific testing, such as UEFI security configuration validation
  - Ongoing security reviews by US-based security experts, with attestation letters available from

our third-party security partners

- Digitally signed firmware, stored and built on US-based infrastructure and signed on US-based Hardware Security Modules (HSMs)
- Manufacturing transparency via Intel Transparent Supply Chain (for details, see <https://lenovopress.com/lp1434-introduction-to-intel-transparent-supply-chain-on-lenovo-thinksystem-servers>)
- TAA (Trade Agreements Act) compliant manufacturing, by default in Mexico for North American markets with additional US and EU manufacturing options
- US 2019 NDAA (National Defense Authorization Act) Section 889 compliant

## Rack installation

The following table lists the rack installation options that are available for the SR630 V3.

Table 73. Rack installation options

Part number	Feature Code	Description
Rail slides		
4M17A13564	BK7W	ThinkSystem Toolless Friction Rail v2
4M17A11754	B8LA	ThinkSystem Toolless Slide Rail Kit v2
4M17A11758	B8LC	ThinkSystem Toolless Slide Rail Kit v2 with 1U CMA
Cable Management Arm		
7M27A05699	B136	ThinkSystem 1U CMA Upgrade Kit for Toolless Slide Rail

The following table summarizes the rail kit features and specifications.

Table 74. Rail kit features and specifications summary

Option name	ThinkSystem Toolless Friction Rail v2	ThinkSystem Toolless Slide Rail Kit v2	ThinkSystem Toolless Slide Rail Kit v2 with 1U CMA
Option part number	4M17A13564	4M17A11754	4M17A11758
Rail type	Half-out slide rail (friction)	Full-out slide rail (ball bearing)	Full-out slide rail (ball bearing)
Toolless installation	Yes	Yes	Yes
CMA support	No	Optional, 7M27A05699*	Included
Supported rack type	Four-post IBM and Lenovo standard rack, complying with the IEC standard	Four-post IBM and Lenovo standard rack, complying with the IEC standard	Four-post IBM and Lenovo standard rack, complying with the IEC standard
In-rack server maintenance	No	Yes	Yes
1U PDU support	Yes	Yes	Yes
0U PDU support	Yes	Limited support**	Limited support**
Supported mounting holes	Square or round	Square or round	Square or round
Thickness of mounting flanges	2.0-3.3 mm (0.08-0.13 inches)	2.0-3.3 mm (0.08-0.13 inches)	2.0-3.3 mm (0.08-0.13 inches)
Supported distance between front and rear mounting flanges ‡	610-864 mm (24-34 inches)	610-813 mm (24-32 inches)	610-813 mm (24-32 inches)
Rail length†	751 mm (29.6 inches)	740 mm (29.1 inches)	820 mm (32.3 inches)

\* CMA mounting brackets are not preinstalled on the rail. The CMA mounting brackets are contained in the CMA option kit package and you will need to install the CMA mounting brackets first. For detailed instructions, refer to the documentation that comes with the CMA option kit.

\*\* If you want to install the rails and a 0U PDU into the same rack, the rack must meet the height and depth requirements as described in [ThinkSystem Rail Support Matrix](#).

‡ For best performance, it is recommended that you install the rails to the racks with a 719-mm distance (28.31-inch, Lenovo rack default distance) between the front and rear mounting flanges.

† Measured when mounted on the rack, from the front surface of the front mounting flange to the rear most point of the rail. Rail is in closed position.

## Operating system support

The SR630 V3 supports the following operating systems:

- Microsoft Windows Server 2019
- Microsoft Windows Server 2022
- Red Hat Enterprise Linux 8.6
- Red Hat Enterprise Linux 8.7
- Red Hat Enterprise Linux 9.0
- Red Hat Enterprise Linux 9.1
- SUSE Linux Enterprise Server 15 SP4
- SUSE Linux Enterprise Server 15 Xen SP4
- Ubuntu 22.04 LTS 64-bit
- VMware ESXi 7.0 U3
- VMware ESXi 8.0

For a complete list of supported, certified and tested operating systems, plus additional details and links to relevant web sites, see the Operating System Interoperability Guide:

<https://lenovopress.lenovo.com/osig#servers=sr630-v3-7d72-7d73>

For configure-to-order configurations, the server can be preloaded with VMware ESXi installed on M.2 cards. Ordering information is listed in the following table.

Table 75. VMware ESXi preload

Feature code	Description
BMEY	VMware ESXi 7.0 U3 (Factory Installed)
BMT5	VMware ESXi 8.0 (Factory Installed)

You can download supported VMware vSphere hypervisor images from the following web page and load it on the M.2 drives or 7mm drives using the instructions provided:

[https://vmware.lenovo.com/content/custom\\_iso/](https://vmware.lenovo.com/content/custom_iso/)

## Physical and electrical specifications

The SR630 V3 has the following overall physical dimensions, excluding components that extend outside the standard chassis, such as EIA flanges, front security bezel (if any), and power supply handles:

- Width: 440 mm (17.3 inches)
- Height: 43 mm (1.7 inches)
- Depth: 773 mm (30.4 inches)

The following table lists the detailed dimensions. See the figure below for the definition of each dimension.

Table 76. Detailed dimensions

Dimension	Description
482 mm	$X_a$ = Width, to the outsides of the front EIA flanges
435 mm	$X_b$ = Width, to the rack rail mating surfaces
440 mm	$X_c$ = Width, to the outer most chassis body feature
43 mm	$Y_a$ = Height, from the bottom of chassis to the top of the chassis
724 mm	$Z_a$ = Depth, from the rack flange mating surface to the rearmost I/O port surface
738 mm	$Z_b$ = Depth, from the rack flange mating surface to the rearmost feature of the chassis body
754 mm ( $\leq 1100W$ PSU) 782 mm (1800W PSU)	$Z_c$ = Depth, from the rack flange mating surface to the rearmost feature such as power supply handle
36 mm	$Z_d$ = Depth, from the forwardmost feature on front of EIA flange to the rack flange mating surface
47 mm	$Z_e$ = Depth, from the front of security bezel (if applicable) or forwardmost feature to the rack flange mating surface

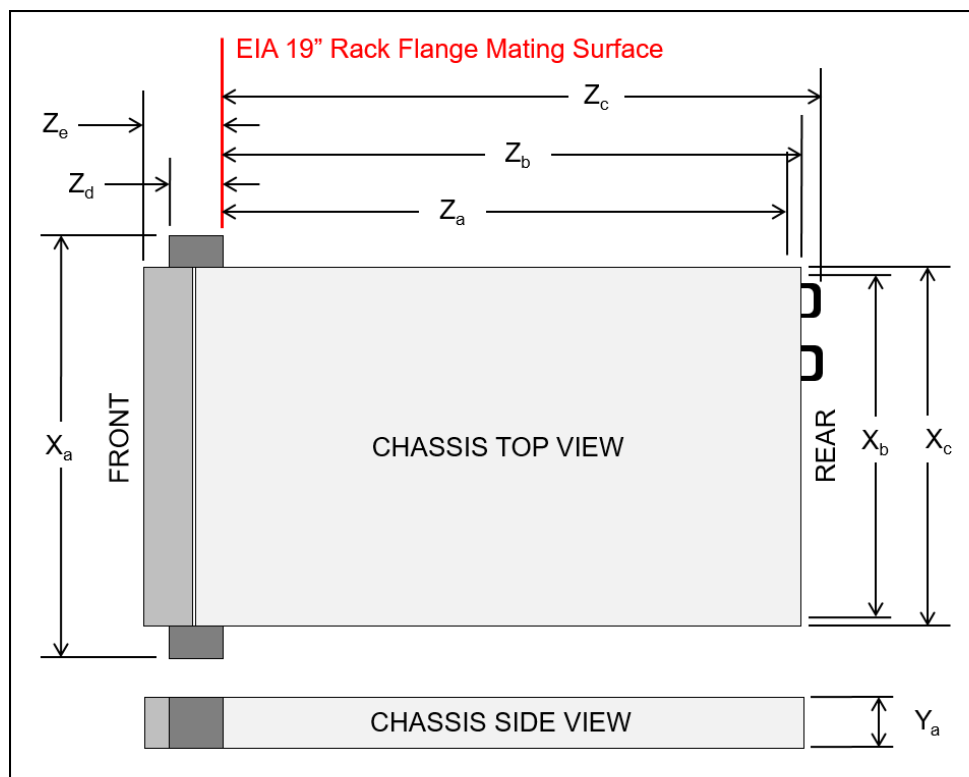

Figure 22. Server dimensions

The shipping dimensions (cardboard packaging) of the SR630 V3 are as follows:

- Width: 587 mm (23.1 inches)
- Height: 225 mm (8.9 inches)
- Depth: 998 mm (39.3 inches)

The server has the following weight:

- Base configuration: 15.1 kg (33.3 lb)
- Maximum weight: 20.2 kg (44.5 lb)

The server has the following electrical specifications for AC input power supplies:

- Input voltage:
  - 100 to 127 (nominal) Vac, 50 Hz or 60 Hz
  - 200 to 240 (nominal) Vac, 50 Hz or 60 Hz
  - 180 to 300 Vdc (China only)
- Inlet current: see the following table.

Table 77. Maximum inlet current

Part number	Description	100V AC	200V AC	220V AC	240V DC
<b>AC input power - 80 PLUS Titanium efficiency</b>					
4P57A82019	ThinkSystem 750W 230V Titanium Hot-Swap Gen2 Power Supply v3	No support	4A	3.6A	3.3A
4P57A72666	ThinkSystem 1100W 230V Titanium Hot-Swap Gen2 Power Supply	No support	5.9A	5.3A	5A
4P57A78359	ThinkSystem 1800W 230V Titanium Hot-Swap Gen2 Power Supply	No support	9.7A	8.7A	8.3A
<b>AC input power - 80 PLUS Platinum efficiency</b>					
4P57A72670	ThinkSystem 750W 230V/115V Platinum Hot-Swap Gen2 Power Supply v3	8.4A	4.1A	3.69A	3.5A
4P57A72671	ThinkSystem 1100W 230V/115V Platinum Hot-Swap Gen2 Power Supply v3	12A	6A	5.4A	5.1A
4P57A26294	ThinkSystem V2 1800W (230V) Platinum Hot-Swap Power Supply v2	No support	10A	9.1A	9A

Electrical specifications for DC input power supply:

- Input voltage: -48 to -60 Vdc
- Inlet current (1100W power supply): 26 A

## Operating environment

The SR630 V3 server complies with ASHRAE Class A2 specifications with most configurations, and depending on the hardware configuration, also complies with ASHRAE Class A3 and Class A4 specifications. System performance may be impacted when operating temperature is outside ASHRAE A2 specification.

Depending on the hardware configuration, the SR630 V3 server also complies with ASHRAE Class H1 specification. System performance may be impacted when operating temperature is outside ASHRAE H1 specification.

### Temperature and humidity

The server is supported in the following environment:

- Air temperature:
  - Operating:
    - ASHRAE Class A2: 10°C to 35°C (50°F to 95°F); the maximum ambient temperature decreases by 1°C for every 300 m (984 ft) increase in altitude above 900 m (2,953 ft).
    - ASHRAE Class A3: 5°C to 40°C (41°F to 104°F); the maximum ambient temperature decreases by 1°C for every 175 m (574 ft) increase in altitude above 900 m (2,953 ft).
    - ASHRAE Class A4: 5°C to 45°C (41°F to 113°F); the maximum ambient temperature decreases by 1°C for every 125 m (410 ft) increase in altitude above 900 m (2,953 ft).
    - ASHRAE Class H1: 5 °C to 25 °C (41 °F to 77 °F); Decrease the maximum ambient temperature by 1°C for every 500 m (1640 ft) increase in altitude above 900 m (2,953 ft).
  - Server off: 5°C to 45°C (41°F to 113°F)
  - Shipment/storage: -40°C to 60°C (-40°F to 140°F)
- Maximum altitude: 3,050 m (10,000 ft)
- Relative Humidity (non-condensing):
  - Operating
    - ASHRAE Class A2: 8% to 80%; maximum dew point: 21°C (70°F)
    - ASHRAE Class A3: 8% to 85%; maximum dew point: 24°C (75°F)
    - ASHRAE Class A4: 8% to 90%; maximum dew point: 24°C (75°F)
    - ASHRAE Class H1: 8% to 80%; Maximum dew point: 17°C (63°F)
  - Shipment/storage: 8% to 90%

### Acoustical noise emissions

The server has the following acoustic noise emissions declaration:

- Sound power level ( $L_{WA_d}$ ):
  - Idling: 5.6 Bel (Min), 6.7 Bel (Typical), 6.7 Bel (GPU rich), 7.5 Bel (Storage rich)
  - Operating: 7.6 Bel (Min), 8.7 Bel (Typical), 8.3 Bel (GPU rich), 7.7 Bel (Storage rich)
- Sound pressure level ( $L_{pAm}$ ):
  - Idling: 41.3 dBA (Min), 52.5 dBA (Typical), 52.5 dBA (GPU rich), 60.1 dBA (Storage rich)
  - Operating: 61.5 dBA (Min), 72.5 dBA (Typical), 67.8 dBA (GPU rich), 62.8 dBA (Storage rich)

Notes:

- These sound levels were measured in controlled acoustical environments according to procedures specified by ISO7779 and are reported in accordance with ISO 9296.
- The declared acoustic sound levels are based on the following configurations, which may change depending on configuration/conditions :
  - Min: 2x 240W CPU, 24x 64GB RDIMMs, 8x SAS HDD, RAID 440-16i, Broadcom 5719 1GbE RJ45 4-port OCP Ethernet Adapter, 2x 1100W PSU
  - Typical: 2x 300W CPU, 24x 64GB RDIMMs, 10x SAS HDD, RAID 940-16i, Broadcom 5719 1GbE RJ45 4-port OCP Ethernet Adapter, 2x 1100W PSU

- GPU rich: 2x 300W CPU, 24x 64GB RDIMMs, 10x SAS HDD, RAID 940-16i, Broadcom 5719 1GbE RJ45 4-port OCP Ethernet Adapter, 1x A2 GPU, 2x 1100W PSU
- Storage rich: 2x 240W CPU, 12x 64GB RDIMMs, 12x SAS HDD, RAID 940-16i, Broadcom 5719 1GbE RJ45 4-port OCP Ethernet Adapter, 2x 750W PSU
- Government regulations (such as those prescribed by OSHA or European Community Directives) may govern noise level exposure in the workplace and may apply to you and your server installation. The actual sound pressure levels in your installation depend upon a variety of factors, including the number of racks in the installation; the size, materials, and configuration of the room; the noise levels from other equipment; the room ambient temperature, and employee's location in relation to the equipment. Further, compliance with such government regulations depends on a variety of additional factors, including the duration of employees' exposure and whether employees wear hearing protection. Lenovo recommends that you consult with qualified experts in this field to determine whether you are in compliance with the applicable regulations.

### Shock and vibration

The server has the following vibration and shock limits:

- Vibration:
  - Operating: 0.21 G rms at 5 Hz to 500 Hz for 15 minutes across 3 axes
  - Non-operating: 1.04 G rms at 2 Hz to 200 Hz for 15 minutes across 6 surfaces
- Shock:
  - Operating: 15 G for 3 milliseconds in each direction (positive and negative X, Y, and Z axes)
  - Non-operating:
    - 12 kg - 22 kg: 50 G for 152 in./sec velocity change across 6 surfaces

### Particulate contamination

Airborne particulates (including metal flakes or particles) and reactive gases acting alone or in combination with other environmental factors such as humidity or temperature might damage the system that might cause the system to malfunction or stop working altogether.

The following specifications indicate the limits of particulates that the system can tolerate:

- Reactive gases:
  - The reactivity rate of copper coupons shall be less than 200 Angstroms per month (Å/month)
  - The reactivity rate of silver coupons shall be less than 200 Å/month
- Airborne particulates:
  - The room air should be continuously filtered with MERV 8 filters.
  - Air entering a data center should be filtered with MERV 11 or preferably MERV 13 filters.
  - The deliquescent relative humidity of the particulate contamination should be more than 60% RH
  - Data centers must be free of zinc whiskers

For additional information, see the Specifications section of the Setup Guide for the server, available from the Lenovo ThinkSystem Information Center, <https://thinksystem.lenovofiles.com/help/index.jsp>

### Warranty and Support

The SR630 V3 has a 1-year or 3-year warranty based on the machine type of the system:

- 7D72 - 1 year warranty
- 7D73 - 3 year warranty

The standard warranty terms are customer-replaceable unit (CRU) and onsite (for field-replaceable units FRUs only) with standard call center support during normal business hours and 9x5 Next Business Day Parts Delivered.



Lenovo's additional support services provide a sophisticated, unified support structure for your data center, with an experience consistently ranked number one in customer satisfaction worldwide. Available offerings include:

- **Premier Support**

Premier Support provides a Lenovo-owned customer experience and delivers direct access to technicians skilled in hardware, software, and advanced troubleshooting, in addition to the following:

- Direct technician-to-technician access through a dedicated phone line
- 24x7x365 remote support
- Single point of contact service
- End to end case management
- Third-party collaborative software support
- Online case tools and live chat support
- On-demand remote system analysis

- **Warranty Upgrade (Preconfigured Support)**

Services are available to meet the on-site response time targets that match the criticality of your systems.

- 3, 4, or 5 years of service coverage
- 1-year or 2-year post-warranty extensions
- **Foundation Service:** 9x5 service coverage with next business day onsite response. YourDrive YourData is an optional extra (see below).
- **Essential Service:** 24x7 service coverage with 4-hour onsite response or 24-hour committed repair (available only in select markets). Bundled with YourDrive YourData.
- **Advanced Service:** 24x7 service coverage with 2-hour onsite response or 6-hour committed repair (available only in select markets). Bundled with YourDrive YourData.

- **Managed Services**

Lenovo Managed Services provides continuous 24x7 remote monitoring (plus 24x7 call center availability) and proactive management of your data center using state-of-the-art tools, systems, and practices by a team of highly skilled and experienced Lenovo services professionals.

Quarterly reviews check error logs, verify firmware & OS device driver levels, and software as needed. We'll also maintain records of latest patches, critical updates, and firmware levels, to ensure you systems are providing business value through optimized performance.

- **Technical Account Management (TAM)**

A Lenovo Technical Account Manager helps you optimize the operation of your data center based on a deep understanding of your business. You gain direct access to your Lenovo TAM, who serves as your single point of contact to expedite service requests, provide status updates, and furnish reports to track incidents over time. In addition, your TAM will help proactively make service recommendations and manage your service relationship with Lenovo to make certain your needs are met.

- **Enterprise Server Software Support**

Enterprise Software Support is an additional support service providing customers with software support on Microsoft, Red Hat, SUSE, and VMware applications and systems. Around the clock availability for critical problems plus unlimited calls and incidents helps customers address challenges fast, without incremental costs. Support staff can answer troubleshooting and diagnostic questions, address product comparability and interoperability issues, isolate causes of problems, report defects to software vendors, and more.

- **YourDrive YourData**

Lenovo's YourDrive YourData is a multi-drive retention offering that ensures your data is always under your control, regardless of the number of drives that are installed in your Lenovo server. In the unlikely event of a drive failure, you retain possession of your drive while Lenovo replaces the failed drive part. Your data stays safely on your premises, in your hands. The YourDrive YourData service can be purchased in convenient bundles and is optional with Foundation Service. It is bundled with Essential Service and Advanced Service.

- **Health Check**

Having a trusted partner who can perform regular and detailed health checks is central to maintaining efficiency and ensuring that your systems and business are always running at their best. Health Check supports Lenovo-branded server, storage, and networking devices, as well as select Lenovo-supported products from other vendors that are sold by Lenovo or a Lenovo-Authorized Reseller.

Examples of region-specific warranty terms are second or longer business day parts delivery or parts-only base warranty.

If warranty terms and conditions include onsite labor for repair or replacement of parts, Lenovo will dispatch a service technician to the customer site to perform the replacement. Onsite labor under base warranty is limited to labor for replacement of parts that have been determined to be field-replaceable units (FRUs). Parts that are determined to be customer-replaceable units (CRUs) do not include onsite labor under base warranty.

If warranty terms include parts-only base warranty, Lenovo is responsible for delivering only replacement parts that are under base warranty (including FRUs) that will be sent to a requested location for self-service. Parts-only service does not include a service technician being dispatched onsite. Parts must be changed at customer's own cost and labor and defective parts must be returned following the instructions supplied with the spare parts.

Lenovo Service offerings are region-specific. Not all preconfigured support and upgrade options are available in every region. For information about Lenovo service upgrade offerings that are available in your region, refer to the following resources:

- Service part numbers in Lenovo Data Center Solution Configurator (DCSC):  
<http://dcsc.lenovo.com/#/services>
- Lenovo Services Availability Locator  
<http://lenovocator.com/>

For service definitions, region-specific details, and service limitations, please refer to the following documents:

- Lenovo Statement of Limited Warranty for Infrastructure Solutions Group (ISG) Servers and System Storage  
<http://pcsupport.lenovo.com/us/en/solutions/ht503310>
- Lenovo Data Center Services Agreement  
<http://support.lenovo.com/us/en/solutions/ht116628>

## Services

Lenovo Services is a dedicated partner to your success. Our goal is to reduce your capital outlays, mitigate your IT risks, and accelerate your time to productivity.

**Note:** Some service options may not be available in all markets or regions. For more information, go to <https://www.lenovo.com/services>. For information about Lenovo service upgrade offerings that are available in your region, contact your local Lenovo sales representative or business partner.

Here's a more in-depth look at what we can do for you:

- **Asset Recovery Services**

Asset Recovery Services (ARS) helps customers recover the maximum value from their end-of-life equipment in a cost-effective and secure way. On top of simplifying the transition from old to new equipment, ARS mitigates environmental and data security risks associated with data center equipment disposal. Lenovo ARS is a cash-back solution for equipment based on its remaining market value, yielding maximum value from aging assets and lowering total cost of ownership for your customers. For more information, see the ARS page, <https://lenovopress.com/lp1266-reduce-e-waste-and-grow-your-bottom-line-with-lenovo-ars>.

- **Assessment Services**

An Assessment helps solve your IT challenges through an onsite, multi-day session with a Lenovo technology expert. We perform a tools-based assessment which provides a comprehensive and thorough review of a company's environment and technology systems. In addition to the technology based functional requirements, the consultant also discusses and records the non-functional business requirements, challenges, and constraints. Assessments help organizations like yours, no matter how large or small, get a better return on your IT investment and overcome challenges in the ever-changing technology landscape.

- **Design Services**

Professional Services consultants perform infrastructure design and implementation planning to support your strategy. The high-level architectures provided by the assessment service are turned into low level designs and wiring diagrams, which are reviewed and approved prior to implementation. The implementation plan will demonstrate an outcome-based proposal to provide business capabilities through infrastructure with a risk-mitigated project plan.

- **Basic Hardware Installation**

Lenovo experts can seamlessly manage the physical installation of your server, storage, or networking hardware. Working at a time convenient for you (business hours or off shift), the technician will unpack and inspect the systems on your site, install options, mount in a rack cabinet, connect to power and network, check and update firmware to the latest levels, verify operation, and dispose of the packaging, allowing your team to focus on other priorities.

- **Deployment Services**

When investing in new IT infrastructures, you need to ensure your business will see quick time to value with little to no disruption. Lenovo deployments are designed by development and engineering teams who know our Products & Solutions better than anyone else, and our technicians own the process from delivery to completion. Lenovo will conduct remote preparation and planning, configure & integrate systems, validate systems, verify and update appliance firmware, train on administrative tasks, and provide post-deployment documentation. Customer's IT teams leverage our skills to enable IT staff to transform with higher level roles and tasks.

- **Integration, Migration, and Expansion Services**

Move existing physical & virtual workloads easily, or determine technical requirements to support increased workloads while maximizing performance. Includes tuning, validation, and documenting ongoing run processes. Leverage migration assessment planning documents to perform necessary migrations.

## Regulatory compliance

The SR630 V3 conforms to the following standards:

- ANSI/UL 62368-1
- IEC 62368-1 (CB Certificate and CB Test Report)
- FCC - Verified to comply with Part 15 of the FCC Rules, Class A
- Canada ICES-003, issue 7, Class A
- CSA C22.2 No. 62368-1
- CISPR 32, Class A, CISPR 35
- Japan VCCI, Class A
- Taiwan BSMI CNS13438, Class A; CNS14336-1; Section 5 of CNS15663
- CE, UKCA Mark (EN55032 Class A, EN62368-1, EN55024, EN55035, EN61000-3-2, EN61000-3-3, (EU) 2019/424, and EN50581-1 (RoHS))
- Korea KN32, Class A, KN35
- Russia, Belorussia and Kazakhstan, TP EAC 037/2016 (for RoHS)
- Russia, Belorussia and Kazakhstan, EAC: TP TC 004/2011 (for Safety); TP TC 020/2011 (for EMC)
- Australia/New Zealand AS/NZS CISPR 32, Class A; AS/NZS 62368.1
- UL Green Guard, UL2819
- Energy Star 3.0
- EPEAT (NSF/ ANSI 426) Bronze
- China CCC certificate, GB17625.1; GB4943.1; GB/T9254
- China CECP certificate, CQC3135
- China CELP certificate, HJ 2507-2011
- Japanese Energy-Saving Act
- Mexico NOM-019
- TUV-GS (EN62368-1, and EK1-ITB2000)
- India BIS 13252 (Part 1)
- Germany GS

## External drive enclosures

The server supports attachment to external drive enclosures using a RAID controller with external ports or a SAS host bus adapter. Adapters supported by the server are listed in the [SAS adapters for external storage](#) section.

**Note:** Information provided in this section is for ordering reference purposes only. For the operating system and adapter support details, refer to the interoperability matrix for a particular storage enclosure that can be found on the Lenovo Data Center Support web site:

<http://datacentersupport.lenovo.com>

Table 78. External drive enclosures

Description	Part number		
	Worldwide	Japan	PRC
Lenovo Storage D1212 LFF Disk Expansion with Dual SAS IO Modules	4587A11	4587A1J	4587A1C
Lenovo Storage D1224 SFF Disk Expansion with Dual SAS IO Modules	4587A31	4587A3J	4587A3C
Lenovo Storage D3284 4TB x 84 HD Expansion Enclosure	641311F		
Lenovo Storage D3284 6TB x 84 HD Expansion Enclosure	641312F		
Lenovo Storage D3284 8TB x 84 HD Expansion Enclosure	641313F		
Lenovo Storage D3284 10TB x 84 HD Expansion Enclosure	641314F		

For details about supported drives, adapters, and cables, see the following Lenovo Press Product Guides:

- Lenovo Storage D1212 and D1224  
<http://lenovopress.com/lp0512>
- Lenovo Storage D3284  
<http://lenovopress.com/lp0513>

## External storage systems

Lenovo offers the ThinkSystem DE Series and ThinkSystem DM Series external storage systems for high-performance storage. See the DE Series and DM Series product guides for specific controller models, expansion enclosures and configuration options:

- ThinkSystem DE Series Storage  
<https://lenovopress.com/storage/thinksystem/de-series#rt=product-guide>
- ThinkSystem DM Series Storage  
<https://lenovopress.com/storage/thinksystem/dm-series#rt=product-guide>

## External backup units

The following table lists the external backup options that are offered by Lenovo.

Table 79. External backup options

Part number	Description
External RDX USB drives	
4T27A10725	ThinkSystem RDX External USB 3.0 Dock
External SAS tape backup drives	
6160S7E	IBM TS2270 Tape Drive Model H7S
6160S8E	IBM TS2280 Tape Drive Model H8S
6160S9E	IBM TS2290 Tape Drive Model H9S
External SAS tape backup autoloaders	
6171S7R	IBM TS2900 Tape Autoloader w/LTO7 HH SAS
6171S8R	IBM TS2900 Tape Autoloader w/LTO8 HH SAS
6171S9R	IBM TS2900 Tape Autoloader w/LTO9 HH SAS
External tape backup libraries	
6741A1F	IBM TS4300 3U Tape Library-Base Unit
6741A3F	IBM TS4300 3U Tape Library-Expansion Unit
Full High 8 Gb Fibre Channel for TS4300	
01KP938	LTO 7 FH Fibre Channel Drive
01KP954	LTO 8 FH Fibre Channel Drive
02JH837	LTO 9 FH Fibre Channel Drive
Half High 8 Gb Fibre Channel for TS4300	
01KP936	LTO 7 HH Fibre Channel Drive
01KP952	LTO 8 HH Fibre Channel Drive
02JH835	LTO 9 HH Fibre Channel Drive
Half High 6 Gb SAS for TS4300	
01KP937	LTO 7 HH SAS Drive
01KP953	LTO 8 HH SAS Drive
02JH836	LTO 9 HH SAS Drive

For more information, see the list of Product Guides in the Backup units category:

<https://lenovopress.com/servers/options/backup>

## Fibre Channel SAN switches

Lenovo offers the ThinkSystem DB Series of Fibre Channel SAN switches for high-performance storage expansion. See the DB Series product guides for models and configuration options:

- ThinkSystem DB Series SAN Switches:  
<https://lenovopress.com/storage/switches/rack#rt=product-guide>

## Uninterruptible power supply units

The following table lists the uninterruptible power supply (UPS) units that are offered by Lenovo.

Table 80. Uninterruptible power supply units

Part number	Description
55941AX	RT1.5kVA 2U Rack or Tower UPS (100-125VAC)
55941KX	RT1.5kVA 2U Rack or Tower UPS (200-240VAC)
55942AX	RT2.2kVA 2U Rack or Tower UPS (100-125VAC)
55942KX	RT2.2kVA 2U Rack or Tower UPS (200-240VAC)
55943AX	RT3kVA 2U Rack or Tower UPS (100-125VAC)
55943KX	RT3kVA 2U Rack or Tower UPS (200-240VAC)
55945KX	RT5kVA 3U Rack or Tower UPS (200-240VAC)
55946KX	RT6kVA 3U Rack or Tower UPS (200-240VAC)
55948KX	RT8kVA 6U Rack or Tower UPS (200-240VAC)
55949KX	RT11kVA 6U Rack or Tower UPS (200-240VAC)
55948PX	RT8kVA 6U 3:1 Phase Rack or Tower UPS (380-415VAC)
55949PX	RT11kVA 6U 3:1 Phase Rack or Tower UPS (380-415VAC)
55943KT†	ThinkSystem RT3kVA 2U Standard UPS (200-230VAC) (2x C13 10A, 2x GB 10A, 1x C19 16A outlets)
55943LT†	ThinkSystem RT3kVA 2U Long Backup UPS (200-230VAC) (2x C13 10A, 2x GB 10A, 1x C19 16A outlets)
55946KT†	ThinkSystem RT6kVA 5U UPS (200-230VAC) (2x C13 10A outlets, 1x Terminal Block output)
5594XKT†	ThinkSystem RT10kVA 5U UPS (200-230VAC) (2x C13 10A outlets, 1x Terminal Block output)

† Only available in China and the Asia Pacific market.

For more information, see the list of Product Guides in the UPS category:

<https://lenovopress.com/servers/options/ups>

## Power distribution units

The following table lists the power distribution units (PDUs) that are offered by Lenovo.

Table 81. Power distribution units

Part number	Feature code	Description	ANZ	ASEAN	Brazil	EET	MEA	RUCIS	WE	HTK	INDIA	JAPAN	LA	NA	PRC
<b>0U Basic PDUs</b>															
00YJ776	ATZY	0U 36 C13/6 C19 24A 1 Phase PDU	N	Y	Y	N	N	N	N	N	N	Y	Y	Y	N
00YJ779	ATZX	0U 21 C13/12 C19 48A 3 Phase PDU	N	N	Y	N	N	N	Y	N	N	Y	Y	Y	N
00YJ777	ATZZ	0U 36 C13/6 C19 32A 1 Phase PDU	Y	Y	N	Y	Y	Y	Y	Y	Y	N	N	Y	Y
00YJ778	AU00	0U 21 C13/12 C19 32A 3 Phase PDU	Y	Y	N	Y	Y	Y	Y	Y	Y	N	N	Y	Y
<b>0U Switched and Monitored PDUs</b>															
00YJ783	AU04	0U 12 C13/12 C19 Switched and Monitored 48A 3 Phase PDU	N	N	Y	N	N	N	Y	N	N	Y	Y	Y	N
00YJ781	AU03	0U 20 C13/4 C19 Switched and Monitored 24A 1 Phase PDU	N	N	Y	N	Y	N	Y	N	N	Y	Y	Y	N
00YJ782	AU02	0U 18 C13/6 C19 Switched and Monitored 32A 3 Phase PDU	Y	Y	Y	Y	Y	Y	Y	Y	Y	N	Y	N	Y
00YJ780	AU01	0U 20 C13/4 C19 Switched and Monitored 32A 1 Phase PDU	Y	Y	Y	Y	Y	Y	Y	Y	Y	N	Y	N	Y
<b>1U Switched and Monitored PDUs</b>															
4PU7A81117	BNDV	1U 18 C19/C13 switched and monitored 48A 3P WYE PDU - ETL	N	N	N	N	N	N	N	N	N	N	N	Y	N
4PU7A77467	BLC4	1U 18 C19/C13 Switched and Monitored 80A 3P Delta PDU	N	N	N	N	N	N	N	N	N	Y	N	Y	N
4PU7A77469	BLC6	1U 12 C19/C13 switched and monitored 60A 3P Delta PDU	N	N	N	N	N	N	N	N	N	N	N	Y	N
4PU7A77468	BLC5	1U 12 C19/C13 switched and monitored 32A 3P WYE PDU	Y	Y	Y	Y	Y	Y	Y	Y	Y	N	Y	Y	Y
4PU7A81118	BNDW	1U 18 C19/C13 switched and monitored 48A 3P WYE PDU - CE	Y	Y	Y	Y	Y	Y	Y	Y	Y	N	Y	N	Y
46M4002	5896	1U 9 C19/3 C13 Switched and Monitored DPI PDU	Y	Y	Y	Y	Y	Y	Y	Y	Y	Y	Y	Y	Y
46M4004	5894	1U 12 C13 Switched and Monitored DPI PDU	Y	Y	Y	Y	Y	Y	Y	Y	Y	Y	Y	Y	Y
46M4003	5897	1U 9 C19/3 C13 Switched and Monitored 60A 3 Phase PDU	Y	Y	Y	Y	Y	Y	Y	Y	Y	Y	Y	Y	Y
46M4005	5895	1U 12 C13 Switched and Monitored 60A 3 Phase PDU	Y	Y	Y	Y	Y	Y	Y	Y	Y	Y	Y	Y	Y
<b>1U Ultra Density Enterprise PDUs (9x IEC 320 C13 + 3x IEC 320 C19 outlets)</b>															
71763NU	6051	Ultra Density Enterprise C19/C13 PDU 60A/208V/3PH	N	N	Y	N	N	N	N	N	N	Y	Y	Y	N
71762NX	6091	Ultra Density Enterprise C19/C13 PDU Module	Y	Y	Y	Y	Y	Y	Y	Y	Y	Y	Y	Y	Y
<b>1U C13 Enterprise PDUs (12x IEC 320 C13 outlets)</b>															
39M2816	6030	DPI C13 Enterprise PDU Plus Module (WW)	Y	Y	Y	Y	Y	Y	Y	Y	Y	Y	Y	Y	Y



Part number	Feature code	Description	ANZ	ASEAN	Brazil	EET	MEA	RUCIS	WE	HTK	INDIA	JAPAN	LA	NA	PRC
39Y8941	6010	DPI C13 Enterprise PDU Module (WW)	Y	Y	Y	Y	Y	Y	Y	Y	Y	Y	Y	Y	Y
<b>1U C19 Enterprise PDUs (6x IEC 320 C19 outlets)</b>															
39Y8948	6060	DPI C19 Enterprise PDU Module (WW)	Y	Y	Y	Y	Y	Y	Y	Y	Y	Y	Y	Y	Y
39Y8923	6061	DPI Three-phase 60A/208V C19 Enterprise PDU (US)	N	N	Y	N	N	N	Y	N	N	N	Y	Y	N
<b>1U Front-end PDUs (3x IEC 320 C19 outlets)</b>															
39Y8938	6002	DPI Single-phase 30A/120V Front-end PDU (US)	Y	Y	Y	Y	Y	Y	Y	Y	Y	Y	Y	Y	Y
39Y8939	6003	DPI Single-phase 30A/208V Front-end PDU (US)	Y	Y	Y	Y	Y	Y	Y	Y	Y	Y	Y	Y	Y
39Y8934	6005	DPI Single-phase 32A/230V Front-end PDU (International)	Y	Y	Y	Y	Y	Y	Y	Y	Y	Y	Y	Y	Y
39Y8940	6004	DPI Single-phase 60A/208V Front-end PDU (US)	Y	N	Y	Y	Y	Y	Y	N	N	Y	Y	Y	N
39Y8935	6006	DPI Single-phase 63A/230V Front-end PDU (International)	Y	Y	Y	Y	Y	Y	Y	Y	Y	Y	Y	Y	Y
<b>1U NEMA PDUs (6x NEMA 5-15R outlets)</b>															
39Y8905	5900	DPI 100-127V NEMA PDU	Y	Y	Y	Y	Y	Y	Y	Y	Y	Y	Y	Y	Y
<b>Line cords for 1U PDUs that ship without a line cord</b>															
40K9611	6504	4.3m, 32A/380-415V, EPDU/IEC 309 3P+N+G 3ph wye (non-US) Line Cord	Y	Y	Y	Y	Y	Y	Y	Y	Y	Y	Y	Y	Y
40K9612	6502	4.3m, 32A/230V, EPDU to IEC 309 P+N+G (non-US) Line Cord	Y	Y	Y	Y	Y	Y	Y	Y	Y	Y	Y	Y	Y
40K9613	6503	4.3m, 63A/230V, EPDU to IEC 309 P+N+G (non-US) Line Cord	Y	Y	Y	Y	Y	Y	Y	Y	Y	Y	Y	Y	Y
40K9614	6500	4.3m, 30A/208V, EPDU to NEMA L6-30P (US) Line Cord	Y	Y	Y	Y	Y	Y	Y	Y	Y	Y	Y	Y	Y
40K9615	6501	4.3m, 60A/208V, EPDU to IEC 309 2P+G (US) Line Cord	N	N	Y	N	N	N	Y	N	N	Y	Y	Y	N
40K9617	6505	4.3m, 32A/230V, Souriau UTG Female to AS/NZ 3112 (Aus/NZ) Line Cord	Y	Y	Y	Y	Y	Y	Y	Y	Y	Y	Y	Y	Y
40K9618	6506	4.3m, 32A/250V, Souriau UTG Female to KSC 8305 (S. Korea) Line Cord	Y	Y	Y	Y	Y	Y	Y	Y	Y	Y	Y	Y	Y

For more information, see the Lenovo Press documents in the PDU category:  
<https://lenovopress.com/servers/options/pdu>

## Rack cabinets

The following table lists the supported rack cabinets.

Table 82. Rack cabinets

Part number	Description
93072RX	25U Standard Rack (1000mm)
93072PX	25U Static S2 Standard Rack (1000mm)
7D6DA007WW	ThinkSystem 42U Onyx Primary Heavy Duty Rack Cabinet (1200mm)
7D6DA008WW	ThinkSystem 42U Pearl Primary Heavy Duty Rack Cabinet (1200mm)
93604PX	42U 1200mm Deep Dynamic Rack
93614PX	42U 1200mm Deep Static Rack
93634PX	42U 1100mm Dynamic Rack
93634EX	42U 1100mm Dynamic Expansion Rack
93074RX	42U Standard Rack (1000mm)
7D6EA009WW	ThinkSystem 48U Onyx Primary Heavy Duty Rack Cabinet (1200mm)
7D6EA00AWW	ThinkSystem 48U Pearl Primary Heavy Duty Rack Cabinet (1200mm)
Withdrawn rack cabinets	
201886X	11U Office Enablement Kit
93084PX	42U Enterprise Rack
93084EX	42U Enterprise Expansion Rack
93604EX	42U 1200mm Deep Dynamic Expansion Rack
93614EX	42U 1200mm Deep Static Expansion Rack
93074XX	42U Standard Rack Extension
93634BX	PureFlex System 42U Expansion Rack
93634DX	PureFlex System 42U Expansion Rack
93634AX	PureFlex System 42U Rack
93634CX	PureFlex System 42U Rack
93624PX	47U 1200mm Deep Static Rack
93624EX	47U 1200mm Deep Static Expansion Rack

For specifications about these racks, see the Lenovo Rack Cabinet Reference, available from:  
<https://lenovopress.com/lp1287-lenovo-rack-cabinet-reference>

For more information, see the list of Product Guides in the Rack cabinets category:  
<https://lenovopress.com/servers/options/racks>

## KVM console options

The following table lists the supported KVM consoles.

Table 83. KVM console

Part number	Description
Consoles	
4XF7A73009	ThinkSystem 18.5" LCD Console (with English keyboard)
17238BX	1U 18.5" Standard Console (without keyboard - see the next table)

The following table lists the keyboards supported with the 1U 18.5" Standard Console (now withdrawn).

**Note:** These keyboards are not supported with the ThinkSystem 18.5" LCD Console.

Table 84. Keyboards for 1U 18.5" Standard Console

Part number	Description
7ZB7A05469	ThinkSystem Keyboard w/ Int. Pointing Device USB - Arabic 253 RoHS v2
7ZB7A05468	ThinkSystem Keyboard w/ Int. Pointing Device USB - Belg/UK 120 RoHS v2
7ZB7A05206	ThinkSystem Keyboard w/ Int. Pointing Device USB - Czech 489 RoHS v2
7ZB7A05207	ThinkSystem Keyboard w/ Int. Pointing Device USB - Danish 159 RoHS v2
7ZB7A05208	ThinkSystem Keyboard w/ Int. Pointing Device USB - Dutch 143 RoHS v2
7ZB7A05210	ThinkSystem Keyboard w/ Int. Pointing Device USB - Fr/Canada 445 RoHS v2
7ZB7A05209	ThinkSystem Keyboard w/ Int. Pointing Device USB - French 189 RoHS v2
7ZB7A05211	ThinkSystem Keyboard w/ Int. Pointing Device USB - German 129 RoHS v2
7ZB7A05212	ThinkSystem Keyboard w/ Int. Pointing Device USB - Greek 219 RoHS v2
7ZB7A05213	ThinkSystem Keyboard w/ Int. Pointing Device USB - Hebrew 212 RoHS v2
7ZB7A05214	ThinkSystem Keyboard w/ Int. Pointing Device USB - Hungarian 208 RoHS v2
7ZB7A05215	ThinkSystem Keyboard w/ Int. Pointing Device USB - Italian 141 RoHS v2
7ZB7A05216	ThinkSystem Keyboard w/ Int. Pointing Device USB - Japanese 194 RoHS v2
7ZB7A05217	ThinkSystem Keyboard w/ Int. Pointing Device USB - Korean 413 RoHS v2
7ZB7A05218	ThinkSystem Keyboard w/ Int. Pointing Device USB - LA Span 171 RoHS v2
7ZB7A05219	ThinkSystem Keyboard w/ Int. Pointing Device USB - Norwegian 155 RoHS v2
7ZB7A05220	ThinkSystem Keyboard w/ Int. Pointing Device USB - Polish 214 RoHS v2
7ZB7A05221	ThinkSystem Keyboard w/ Int. Pointing Device USB - Portugese 163 RoHS v2
7ZB7A05222	ThinkSystem Keyboard w/ Int. Pointing Device USB - Russian 441 RoHS v2
7ZB7A05223	ThinkSystem Keyboard w/ Int. Pointing Device USB - Slovak 245 RoHS v2
7ZB7A05231	ThinkSystem Keyboard w/ Int. Pointing Device USB - Slovenian 234 RoHS v2
7ZB7A05224	ThinkSystem Keyboard w/ Int. Pointing Device USB - Spanish 172 RoHS v2
7ZB7A05225	ThinkSystem Keyboard w/ Int. Pointing Device USB - Swed/Finn 153 RoHS v2
7ZB7A05226	ThinkSystem Keyboard w/ Int. Pointing Device USB - Swiss F/G 150 RoHS v2
7ZB7A05227	ThinkSystem Keyboard w/ Int. Pointing Device USB - Thai 191 RoHS v2
7ZB7A05467	ThinkSystem Keyboard with Int. Pointing Device USB - Trad Chinese/US 467 RoHS v2
7ZB7A05228	ThinkSystem Keyboard w/ Int. Pointing Device USB - Turkish 179 RoHS v2
7ZB7A05229	ThinkSystem Keyboard w/ Int. Pointing Device USB - UK Eng 166 RoHS v2
7ZB7A05470	ThinkSystem Keyboard w/ Int. Pointing Device USB - US Eng 103P RoHS v2
7ZB7A05230	ThinkSystem Keyboard w/ Int. Pointing Device USB - US Euro 103P RoHS v2

The following table lists the available KVM switches and the options that are supported with them.

Table 85. KVM switches and options

Part number	Description
KVM Console switches	
1754D1T	ThinkSystem Digital 2x1x16 KVM Switch (DVI video output port)
1754A1T	ThinkSystem Analog 1x8 KVM Switch (DVI video output port)
1754D2X	Global 4x2x32 Console Manager (GCM32)
1754D1X	Global 2x2x16 Console Manager (GCM16)
1754A2X	Local 2x16 Console Manager (LCM16)
1754A1X	Local 1x8 Console Manager (LCM8)
Cables for ThinkSystem Digital and Analog KVM Console switches	
4X97A11108	ThinkSystem VGA to DVI Conversion Cable
4X97A11109	ThinkSystem Single-USB Conversion Cable for Digital KVM
4X97A11107	ThinkSystem Dual-USB Conversion Cable for Digital KVM
4X97A11106	ThinkSystem USB Conversion Cable for Analog KVM
Cables for GCM and LCM Console switches	
43V6147	Single Cable USB Conversion Option (UCO)
39M2895	USB Conversion Option Pack
46M5383	Virtual Media Conversion Option Gen2 (VCO2)
46M5382	Serial Conversion Option (SCO)

For more information, see the list of Product Guides in the KVM Switches and Consoles category:  
<http://lenovopress.com/servers/options/kvm>

## Lenovo Financial Services

Lenovo Financial Services reinforces Lenovo's commitment to deliver pioneering products and services that are recognized for their quality, excellence, and trustworthiness. Lenovo Financial Services offers financing solutions and services that complement your technology solution anywhere in the world.

We are dedicated to delivering a positive finance experience for customers like you who want to maximize your purchase power by obtaining the technology you need today, protect against technology obsolescence, and preserve your capital for other uses.

We work with businesses, non-profit organizations, governments and educational institutions to finance their entire technology solution. We focus on making it easy to do business with us. Our highly experienced team of finance professionals operates in a work culture that emphasizes the importance of providing outstanding customer service. Our systems, processes and flexible policies support our goal of providing customers with a positive experience.

We finance your entire solution. Unlike others, we allow you to bundle everything you need from hardware and software to service contracts, installation costs, training fees, and sales tax. If you decide weeks or months later to add to your solution, we can consolidate everything into a single invoice.

Our Premier Client services provide large accounts with special handling services to ensure these complex transactions are serviced properly. As a premier client, you have a dedicated finance specialist who manages your account through its life, from first invoice through asset return or purchase. This specialist develops an in-depth understanding of your invoice and payment requirements. For you, this dedication provides a high-quality, easy, and positive financing experience.

For your region-specific offers, please ask your Lenovo sales representative or your technology provider about the use of Lenovo Financial Services. For more information, see the following Lenovo website:

<https://www.lenovo.com/us/en/landingpage/lenovo-financial-services/>

## Related publications and links

For more information, see these resources:

- Lenovo ThinkSystem SR630 V3 product page:  
<https://www.lenovo.com/us/en/p/racks/len21ts0012>
- ThinkSystem SR630 V3 datasheet  
<https://lenovopress.com/ds0142>
- Interactive 3D Tour of the ThinkSystem SR630 V3:  
<https://lenovopress.com/lp1620>
- ThinkSystem SR630 V3 drivers and support  
<http://datacentersupport.lenovo.com/products/servers/thinksystem/sr630v3/7d73/downloads>
- Lenovo Hardware Installation & Removal Videos on the SR630 V3:  
<https://www.youtube.com/playlist?list=PLYV5R7hVcs-CfNsWy-689CRZHExtZEi9I>
- Lenovo ThinkSystem SR630 V3 product publications:  
<https://pubs.lenovo.com/sr630-v3/>
  - User Guide, which includes:
    - System Configuration Guide
    - Hardware Maintenance Guide
  - Rack Installation Guides
  - Messages and Codes Reference
  - UEFI Manual for ThinkSystem Servers
- User Guides for options:  
<https://serveroption.lenovo.com>
- ServerProven hardware compatibility:  
<http://serverproven.lenovo.com>

## Related product families

Product families related to this document are the following:

- [2-Socket Rack Servers](#)
- [ThinkSystem SR630 V3 Server](#)

## Notices

Lenovo may not offer the products, services, or features discussed in this document in all countries. Consult your local Lenovo representative for information on the products and services currently available in your area. Any reference to a Lenovo product, program, or service is not intended to state or imply that only that Lenovo product, program, or service may be used. Any functionally equivalent product, program, or service that does not infringe any Lenovo intellectual property right may be used instead. However, it is the user's responsibility to evaluate and verify the operation of any other product, program, or service. Lenovo may have patents or pending patent applications covering subject matter described in this document. The furnishing of this document does not give you any license to these patents. You can send license inquiries, in writing, to:

Lenovo (United States), Inc.  
8001 Development Drive  
Morrisville, NC 27560  
U.S.A.  
Attention: Lenovo Director of Licensing

LENOVO PROVIDES THIS PUBLICATION "AS IS" WITHOUT WARRANTY OF ANY KIND, EITHER EXPRESS OR IMPLIED, INCLUDING, BUT NOT LIMITED TO, THE IMPLIED WARRANTIES OF NON-INFRINGEMENT, MERCHANTABILITY OR FITNESS FOR A PARTICULAR PURPOSE. Some jurisdictions do not allow disclaimer of express or implied warranties in certain transactions, therefore, this statement may not apply to you.

This information could include technical inaccuracies or typographical errors. Changes are periodically made to the information herein; these changes will be incorporated in new editions of the publication. Lenovo may make improvements and/or changes in the product(s) and/or the program(s) described in this publication at any time without notice.

The products described in this document are not intended for use in implantation or other life support applications where malfunction may result in injury or death to persons. The information contained in this document does not affect or change Lenovo product specifications or warranties. Nothing in this document shall operate as an express or implied license or indemnity under the intellectual property rights of Lenovo or third parties. All information contained in this document was obtained in specific environments and is presented as an illustration. The result obtained in other operating environments may vary. Lenovo may use or distribute any of the information you supply in any way it believes appropriate without incurring any obligation to you.

Any references in this publication to non-Lenovo Web sites are provided for convenience only and do not in any manner serve as an endorsement of those Web sites. The materials at those Web sites are not part of the materials for this Lenovo product, and use of those Web sites is at your own risk. Any performance data contained herein was determined in a controlled environment. Therefore, the result obtained in other operating environments may vary significantly. Some measurements may have been made on development-level systems and there is no guarantee that these measurements will be the same on generally available systems. Furthermore, some measurements may have been estimated through extrapolation. Actual results may vary. Users of this document should verify the applicable data for their specific environment.

© Copyright Lenovo 2023. All rights reserved.

This document, LP1600, was created or updated on March 8, 2023.

Send us your comments in one of the following ways:

- Use the online Contact us review form found at:  
<https://lenovopress.lenovo.com/LP1600>
- Send your comments in an e-mail to:  
[comments@lenovopress.com](mailto:comments@lenovopress.com)

This document is available online at <https://lenovopress.lenovo.com/LP1600>.



## Trademarks

Lenovo and the Lenovo logo are trademarks or registered trademarks of Lenovo in the United States, other countries, or both. A current list of Lenovo trademarks is available on the Web at <https://www.lenovo.com/us/en/legal/copytrade/>.

The following terms are trademarks of Lenovo in the United States, other countries, or both:

Lenovo®  
AnyBay®  
Bootable Media Creator  
Flex System  
Lenovo Services  
ServerProven®  
System x®  
ThinkShield®  
ThinkServer®  
ThinkSystem®  
TopSeller  
UpdateXpress System Packs  
XClarity®

The following terms are trademarks of other companies:

Intel®, Intel Optane™, and Xeon® are trademarks of Intel Corporation or its subsidiaries.

Linux® is the trademark of Linus Torvalds in the U.S. and other countries.

ActiveX®, Hyper-V®, Microsoft®, PowerShell, Windows PowerShell®, Windows Server®, and Windows® are trademarks of Microsoft Corporation in the United States, other countries, or both.

SPECpower® is a trademark of the Standard Performance Evaluation Corporation (SPEC).

Other company, product, or service names may be trademarks or service marks of others.